

DIN 2080

TOOLING SYSTEMS
SPANNWERKZEUGE
TAKIM TUTUCU SİSTEMLERİ

CONTENTS / INHALT / İÇİNDEKİLER

OZ Collet Chuck / OZ Spannzangenfutter OZ Pens Başlığı	102
ER Collet Chuck / ER Spannzangenfutter ER Pens Başlığı	103
Milling Chuck / Kraftspannfutter Bilyalı Pens Başlığı	103
End Mill Holder / Fräseraufnahme Veldon Tutucu	104
Morse Taper Adaptor / Zwischenhülse mit Austreiblappen Mors Adaptörü	105
Morse Taper Adaptor with Thread / Zwischenhülse mit Anzugsg. Çektirmeli Mors Adaptörü	106
Reduction Sleeve / Reduzierhülse Redüksiyon Çektirmeli	107
Combi Shell Mill Holder / Kombi-Aufsteckfräserdorn Kombine Malafa	108
Shell Mill Holder / Messerkopfaufnahme Alın Kamalı Malafa	109
Drill Chuck Adaptor / Bohrfutteraufnahme Mandren Malafası	110
NC-Drill Chuck / Kurzbohrfutter NC-Mandren Malafası	110
Tapping Chuck / Gewindeschneidfutter Kılavuz Çekme Başlığı	111
Blank Toolholder / Bohrstangenrohling Rohling	112
Coolant Feeder / Kühlmittelzuführung Dıştan Soğutmalı Takım Tutucu	112



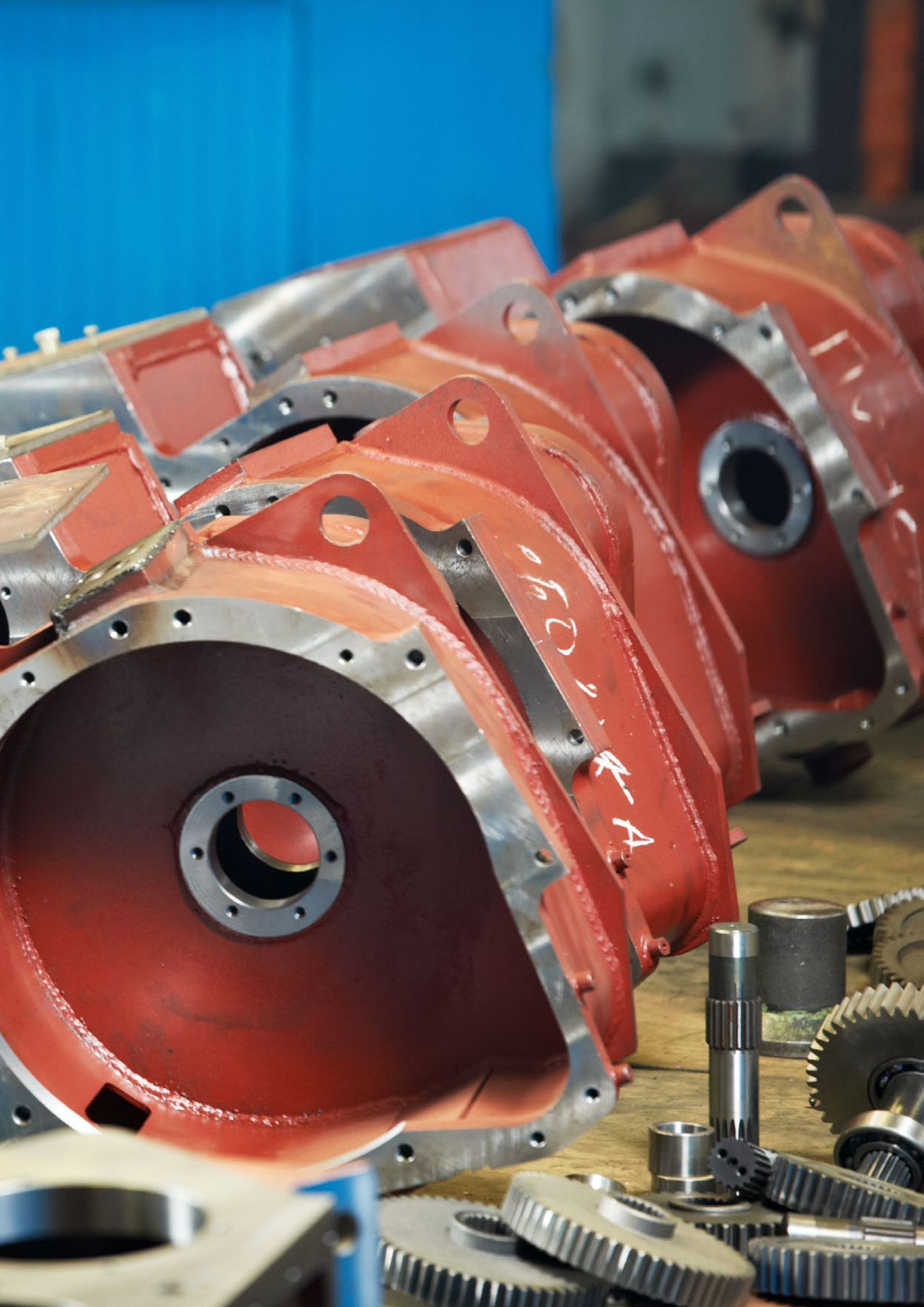



Kegel-Norm

Konik Şaft Ölçüleri

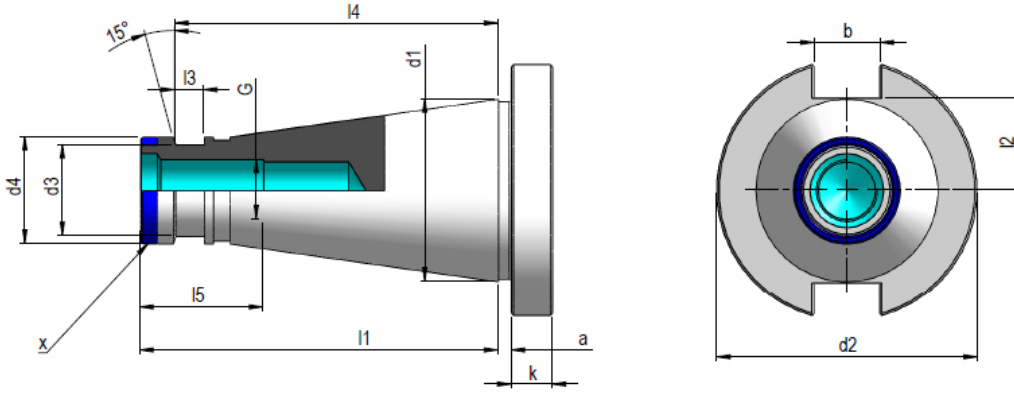

- ★ With plastic protection ring
- ★ Mit Kunststoff - Kantenschutzring
- ★ Plastik köşe koruma, ringli

SK	d ₁	a	b	k	G	d ₂	d ₃	d ₄	l ₁	l ₂	l ₃	l ₄	l ₅
30	31,75	1,6	16,1	8	M12	50	-	17,2	68,4	16,2	-	-	24,0
★ 40	44,45	1,6	16,1	10	M16	63	21,1	25,0	93,4	22,5	7,0	82,0	32,0
★ 50	69,85	3,2	25,7	12	M24	97,5	32,0	39,2	126,8	35,3	13,0	115,0	47,0

Material : Case hardened steel, tensile strength in the core min. 950 N/mm²
Technical Info : Case hardened HRC 58 ± 2 depth of case 0,6 mm ± 0,2 mm, black - finish
Accuracy : Cone angle AT3 according to DIN 2080
 Surface roughness of cone max 0,001 mm

Werkstoff : Legierter Einsatzstahl mit einer Zugfestigkeit im Kern von min. 950 N/mm²
Ausführung : Einsatzgehärtet HRC 58 ± 2 Härtetiefe 0,6 mm ± 0,2 mm, brüniert
Genauigkeit : Kegelwinkel - Toleranzqualität AT3 nach DIN 2080
 Oberflächenrauigkeit des Kegels max. 0,001 mm

Malzeme : Alaşımlı semente çeliği çekme mukavemeti min. 950 N/mm²
Teknik Özelliği : Sertlik HRC 58 ± 2 sertlik derinliği 0,6 mm ± 0,2 mm, karartılmış
Hassasiyeti : Konik açı tolerans kalitesi DIN 2080 normuna göre AT3
 Konik yüzey kalitesi max. 0,001 mm



OZ Collet Chuck DIN 6391

DIN 2080

OZ Spannanzengfutter DIN 6391

OZ Pens Başlığı DIN 6391

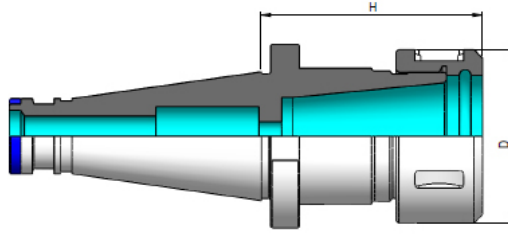

Order No. Bestell-Nr. Sipariş No.	Description Bezeichnung Açıklama	H	D	Capacity Spannbereich Kapasite
540.01.116	ISO40 DIN2080 H70 OZ16	70	43	2-16
540.01.125	ISO40 DIN2080 H70 OZ25	70	60	3-25
540.01.132	ISO40 DIN2080 H85 OZ32	85	72	4-32
550.01.125	ISO50 DIN2080 H70 OZ25	70	60	3-25
550.01.132	ISO50 DIN2080 H80 OZ32	80	72	4-32



Collet
Spannzange
Pens

129



Clamping Nut
Spannmutter
Kapak

138



Wrench
Hakenschlüssel
Ay Anahtarı

142

ER Collet Chuck DIN 6499

DIN 2080



ER Spannanzengenfutter DIN 6499

ER Pens Başığı DIN 6499

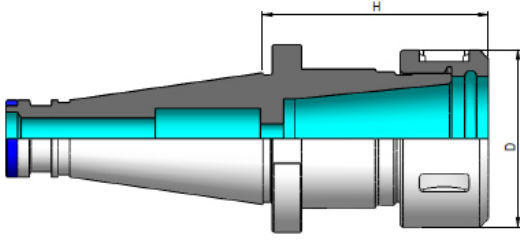

Order No. Bestell-Nr. Sipariş No.	Description Bezeichnung Açıklama	H	D	Capacity Spannbereich Kapasite
540.02.110	ISO40 DIN2080 H70 ER16	70	32	1-10
540.02.116	ISO40 DIN2080 H70 ER25	70	42	2-16
540.02.120	ISO40 DIN2080 H70 ER32	70	50	2-20
540.02.126	ISO40 DIN2080 H70 ER40	70	63	3-26
550.02.110	ISO50 DIN2080 H80 ER16	80	32	1-10
550.02.116	ISO50 DIN2080 H80 ER25	80	42	2-16
550.02.120	ISO50 DIN2080 H80 ER32	80	50	2-20
550.02.126	ISO50 DIN2080 H80 ER40	80	63	3-26

Milling Chuck

Kraftspannfutter

Bilyalı Pens Başığı

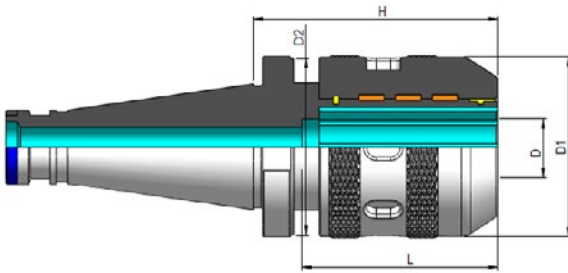

Order No. Bestell-Nr. Sipariş No.	Description Bezeichnung Açıklama	H	L	D	D1	D2	Capacity Spannbereich Kapasite
540.03.120	ISO40 DIN2080 H65 6-20	65	60	20	46	47	6-20
540.03.132	ISO40 DIN2080 H80 6-32	80	80	32	62	63	6-32
550.03.120	ISO50 DIN2080 H70 6-20	70	60	20	46	47	6-20
550.03.132	ISO50 DIN2080 H75 6-32	75	80	32	62	63	6-32

Collet
Spannzange
Pens

128

Clamping Nut
Spannmutter
Kapak

138

Wrench
Spannschlüssel
Ay Anahtarı

142

Collet
Spannzange
Pens

136



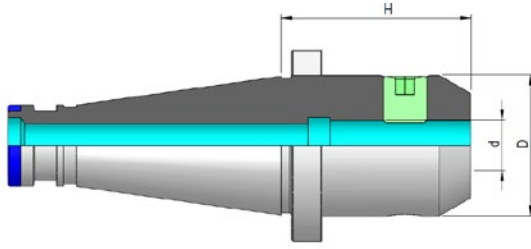

Order No. Bestell-Nr. Sipariş No.	Description Bezeichnung Açıklama	H	D	D1
540.04.106	ISO40 DIN2080 H50 D 6	50	6	25
540.04.108	ISO40 DIN2080 H50 D 8	50	8	28
540.04.110	ISO40 DIN2080 H50 D10	50	10	35
540.04.112	ISO40 DIN2080 H50 D12	50	12	42
540.04.114	ISO40 DIN2080 H50 D14	50	14	44
540.04.116	ISO40 DIN2080 H63 D16	63	16	48
540.04.118	ISO40 DIN2080 H63 D18	63	18	50
540.04.120	ISO40 DIN2080 H63 D20	63	20	52
540.04.125	ISO40 DIN2080 H90 D25	90	25	65
540.04.132	ISO40 DIN2080 H90 D32	90	32	72
540.04.140	ISO40 DIN2080 H90 D40	90	40	78
550.04.106	ISO50 DIN2080 H50 D 6	50	6	25
550.04.108	ISO50 DIN2080 H50 D 8	50	8	28
550.04.110	ISO50 DIN2080 H63 D10	63	10	35
550.04.112	ISO50 DIN2080 H63 D12	63	12	42
550.04.114	ISO50 DIN2080 H63 D14	63	14	44
550.04.116	ISO50 DIN2080 H63 D16	63	16	48
550.04.118	ISO50 DIN2080 H63 D18	63	18	50
550.04.120	ISO50 DIN2080 H63 D20	63	20	52
550.04.125	ISO50 DIN2080 H80 D25	80	25	65
550.04.132	ISO50 DIN2080 H85 D32	85	32	72
550.04.140	ISO50 DIN2080 H95 D40	95	40	78



Clamping Screw
Spannschraube
Sikma Civatası



Zwischenhülse mit Austreibblappen DIN 6383

Mors Adaptörü DIN 6383

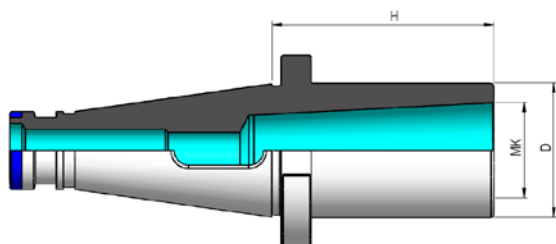

Order No. Bestell-Nr. Sipariş No.	Description Bezeichnung Açıklama	H	D	MK
540.07.101	ISO40 DIN2080 H 50 MK1	50	25	1
540.07.102	ISO40 DIN2080 H 50 MK2	50	32	2
540.07.103	ISO40 DIN2080 H 65 MK3	65	40	3
540.07.104	ISO40 DIN2080 H 95 MK4	95	48	4
550.07.101	ISO50 DIN2080 H 45 MK1	45	25	1
550.07.102	ISO50 DIN2080 H 60 MK2	60	32	2
550.07.103	ISO50 DIN2080 H 65 MK3	65	40	3
550.07.104	ISO50 DIN2080 H 70 MK4	70	48	4
550.07.105	ISO50 DIN2080 H105 MK5	105	63	5

Mors Taper Adaptor with Thread DIN 6364

DIN 2080

Zwischenhülse mit Anzugsgewinde DIN 6364

Çektirmeli Mors Adaptörü DIN 6364

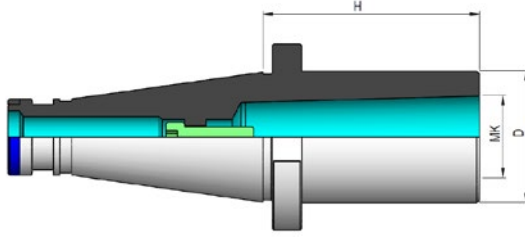

Order No. Bestell-Nr. Sipariş No.	Description Bezeichnung Açıklama	H	D	MK
540.08.101	ISO40 DIN2080 H 50 CMK1	50	25	1
540.08.102	ISO40 DIN2080 H 50 CMK2	50	32	2
540.08.103	ISO40 DIN2080 H 65 CMK3	65	40	3
540.08.104	ISO40 DIN2080 H 95 CMK4	95	48	4
550.08.101	ISO50 DIN2080 H 45 CMK1	45	25	1
550.08.102	ISO50 DIN2080 H 60 CMK2	60	32	2
550.08.103	ISO50 DIN2080 H 65 CMK3	65	40	3
550.08.104	ISO50 DIN2080 H 65 CMK4	65	48	4
550.08.105	ISO50 DIN2080 H120 CMK5	120	63	5

Reduction Sleeve

DIN 2080



Reduzierhülse

Redüksiyon Çektirmeli

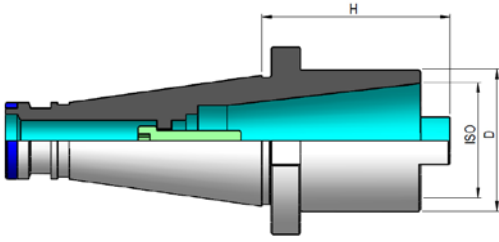

Order No. Bestell-Nr. Sipariş No.	Description Bezeichnung Açıklama	H	D	ISO
540.09.130	ISO40-ISO30 H 50	50	50	30
540.09.140	ISO40-ISO40 H100	100	68	40
550.09.130	ISO50-ISO30 H 16	16	50	30
550.09.140	ISO50-ISO40 H 63	63	78	40
550.09.150	ISO50-ISO50 H100	100	100	50

Combi Shell Mill Holder DIN 6358

DIN 2080

Kombi-Aufsteckfräserdorn DIN 6358

Kombine Malafa DIN 6358

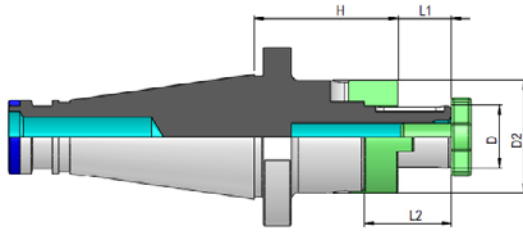

Order No. Bestell-Nr. Sipariş No.	Description Bezeichnung Açıklama	H	D	D2	L1	L2
540.10.116	ISO40 DIN2080 H52 D16	52	16	32	17	27
540.10.122	ISO40 DIN2080 H52 D22	52	22	40	19	31
540.10.127	ISO40 DIN2080 H52 D27	52	27	48	21	33
540.10.132	ISO40 DIN2080 H52 D32	52	32	58	24	38
540.10.140	ISO40 DIN2080 H52 D40	52	40	70	27	41
550.10.116	ISO50 DIN2080 H55 D16	55	16	32	17	27
550.10.122	ISO50 DIN2080 H55 D22	55	22	40	19	31
550.10.127	ISO50 DIN2080 H55 D27	55	27	48	21	33
550.10.132	ISO50 DIN2080 H55 D32	55	32	58	24	38
550.10.140	ISO50 DIN2080 H55 D40	55	40	70	27	41



Clutch Drive Ring
Mitnehmerring
Tırnaklı Pul

152



Draw-in Bolt
Fräseranzugsschraube
Kelebek Civata

152



Wrench
Spannschlüssel
Anahtar

152

Shell Mill Holder DIN 6357

DIN 2080



Messerkopfaufnahme DIN 6357

Alın Kamalı Malafa DIN 6357

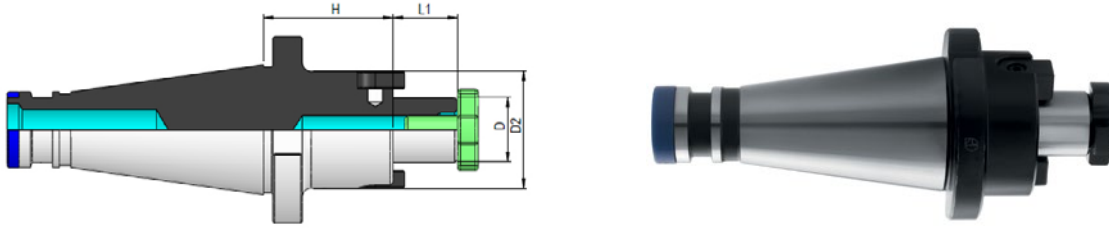

Order No. Bestell-Nr. Sipariş No.	Description Bezeichnung Açıklama	H	D	D1	L1
540.11.116	ISO40 DIN2080 H45 D16	45	16	38	17
540.11.122	ISO40 DIN2080 H45 D22	45	22	48	19
540.11.127	ISO40 DIN2080 H45 D27	45	27	58	21
540.11.132	ISO40 DIN2080 H50 D32	50	32	78	24
540.11.140	ISO40 DIN2080 H55 D40	55	40	88	27
550.11.116	ISO50 DIN2080 H45 D16	45	16	38	17
550.11.122	ISO50 DIN2080 H45 D22	45	22	48	19
550.11.127	ISO50 DIN2080 H45 D27	45	27	58	21
550.11.132	ISO50 DIN2080 H50 D32	50	32	78	24
550.11.140	ISO50 DIN2080 H50 D40	50	40	88	27

Face Mill Holder DIN 6357



Messerkopfaufnahme DIN 6357

Alın Kamalı Malafa DIN 6357

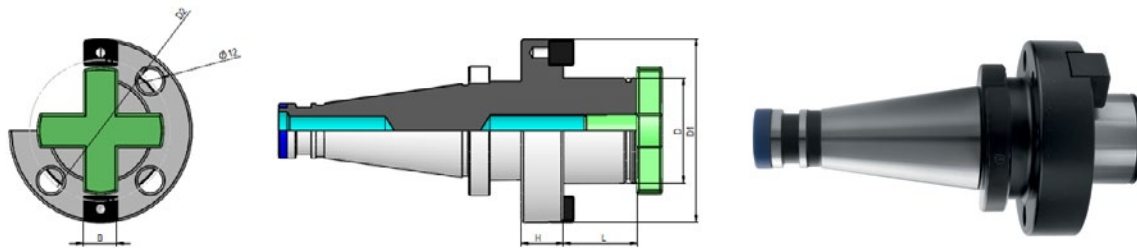

Order No. Bestell-Nr. Sipariş No.	Description Bezeichnung Açıklama	H	L	D	D1	D2	D3	b
540.13.140	ISO40 DIN2080 H20 D40	20	30	40	89	66,7	M12	15,9
550.13.140	ISO50 DIN2080 H30 D40	30	30	40	89	66,7	M12	15,9
550.13.160	ISO50 DIN2080 H30 D60	30	40	60	129	102	M16	25,4



Draw-in Bolt
Fräseranzugsschraube
Kelebek Civata

152



Wrench
Spannschlüssel
Anahtar

152



Drill Chuck Adaptor DIN 238

DIN 2080

Bohrfutteraufnahme DIN 238

Mandren Malafası DIN 238

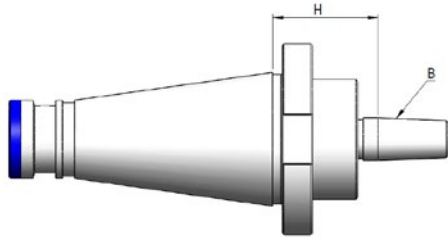

Order No. Bestell-Nr. Sipariş No.	Description Bezeichnung Açıklama	H	B
540.14.112	ISO40 DIN2080 B12 H18	18	12
540.14.116	ISO40 DIN2080 B16 H18	18	16
540.14.118	ISO40 DIN2080 B18 H18	18	18
550.14.112	ISO50 DIN2080 B12 H20	20	12
550.14.116	ISO50 DIN2080 B16 H20	20	16
550.14.118	ISO50 DIN2080 B18 H20	20	18

NC-Drill Chuck for Left and Right Rotation

Kurzbohrfutter für Links- und Rechtslauf

NC-Mandren Malafası, Sağ-Sol Dönüşlü

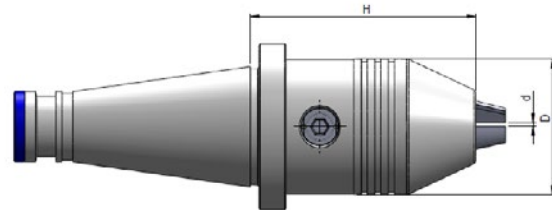

Order No. Bestell-Nr. Sipariş No.	Description Bezeichnung Açıklama	H	D	d
540.15.113	ISO40 DIN2080 H80 d13	80	50	1-13
540.15.116	ISO40 DIN2080 H85,5 d16	85,5	56	2,5-16
550.15.113	ISO50 DIN2080 H83,5 d13	83,5	50	1-13
550.15.116	ISO50 DIN2080 H89 d16	89	56	2,5-16



Drill Chuck
Bohrfutter
Mandren

148



Gewindeschneidfutter mit Längenausgleich

Kılavuz Çekme Başlığı, Kompanzeli

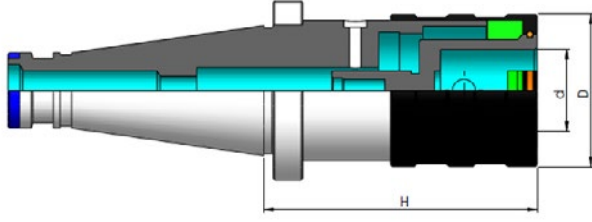

Order No. Bestell-Nr. Sipariş No.	Description Bezeichnung Açıklama	H	d	D	Capacity Spannbereich Kapasite	Compan. - Ext. Druck - zug Giriş - Çıkış
540.16.112	ISO40 DIN2080 H53 GR1	53	19	38	M3-M12	9 - 9
540.16.120	ISO40 DIN2080 H77 GR2	77	31	55	M6-M20	15 - 15
550.16.120	ISO50 DIN2080 H79 GR2	79	31	55	M5-M24	15 - 15



Tapping Collet
Einsatz
Kılavuz Tutucu

Blank Toolholder

DIN 2080

Bohrstangenrohling
Rohling Özel Takım Amaçlı

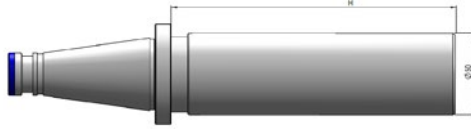

Order No. Bestell-Nr. Sipariş No.	Description Bezeichnung Açıklama	H	D
540.17.263	ISO40 Ø63 x 250	250	63
550.17.397	ISO50 Ø97 x 315	315	97

Coolant Feeder

DIN 2080

Kühlmittelzuführung
Dıştan Soğutmalı Takım Tutucu

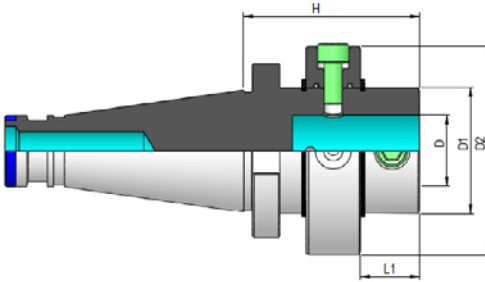

Order No. Bestell-Nr. Sipariş No.	Description Bezeichnung Açıklama	H	L1	D	D1	D2
540.22.140	ISO40 DIN2080 D40	100	35	40	80	118
550.22.140	ISO50 DIN2080 D40	100	36	40	80	118



Reduction Sleeve
Reduzierbuchse
Redüksiyon

137