

HSK-A (DIN 69893-1)

TOOLING SYSTEMS SPANNWERKZEUGE TAKIM TUTUCU SİSTEMLERİ



Gisstec®

CONTENTS / INHALT / İÇİNDEKİLER

OZ Collet Chuck / OZ Spannanzangenfutter OZ Pens Başlığı	74
ER Collet Chuck / ER Spannanzangenfutter ER Pens Başlığı	75
Ultra Precise Collet Chuck / Präzisionsspannanzangenfutter Ultra Hassas Pens Başlığı	78
Milling Chuck / Kraftspannfutter Bilyalı Pens Başlığı	79
Ultra Clamp / Ultra Clamp Ultra Clamp	80
End Mill Holder / Fräseraufnahme Veldon Tutucu	81
Morse Taper Adaptor / Zwischenhülse mit Austreiblappen Mors Adaptörü	86
Morse Taper Adaptor with Thread / Zwischenhülse mit Anzugsg. Çektirmeli Mors Adaptörü	87
Combi Shell Mill Holder / Kombi-Aufsteckfräserdorn Kombine Malafa	88
Shell Mill Holder / Messerkopfaufnahme Alın Kamalı Malafa	89
Milling Cutter Arbor / Fräserdorn für Aufschraubfräser Vidalı Freze Takımı	91
NC-Drill Chuck / Kurzbohrfutter NC-Mandren Malafası	92
Tapping Chuck / Gewindeschneidfutter Kılavuz Çekme Başlığı	93
Synchro Tapping Chuck / Synchro-Gewindeschneidfutter Senkronize Kılavuz Çekme Başlığı	93
Blank Toolholder / Bohrstangenrohling Rohling	94
Test Arbors / Kontrolldorn Kontrol Mastarı	94
Shrink Chuck / Schrumpffutter Isıtmalı Takım Tutucu	95
Hydraulic Chuck / Hydro-Dehnspannfutter Hidrolik Takım Tutucu	98



TOOLING TECHNOLOGY



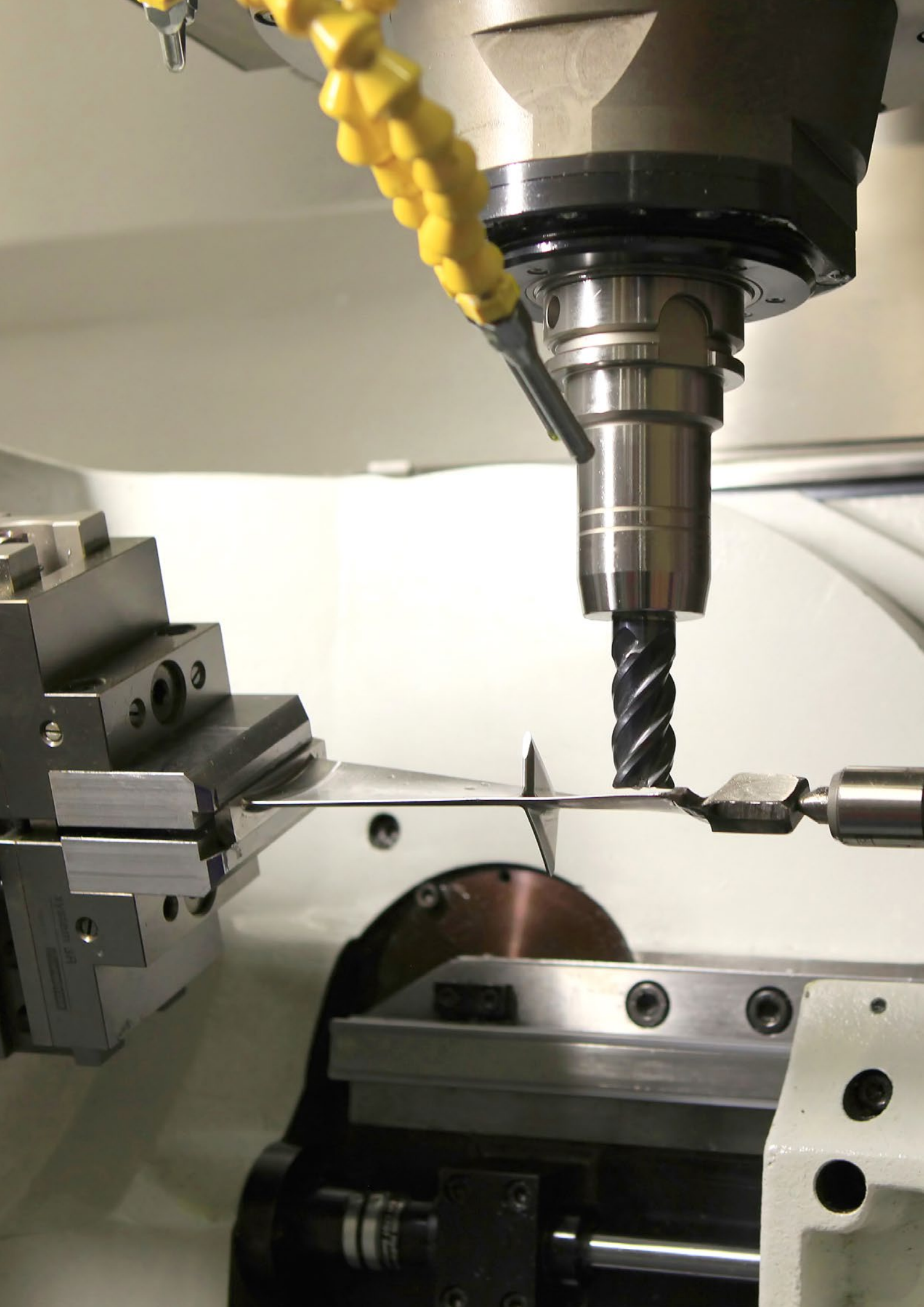

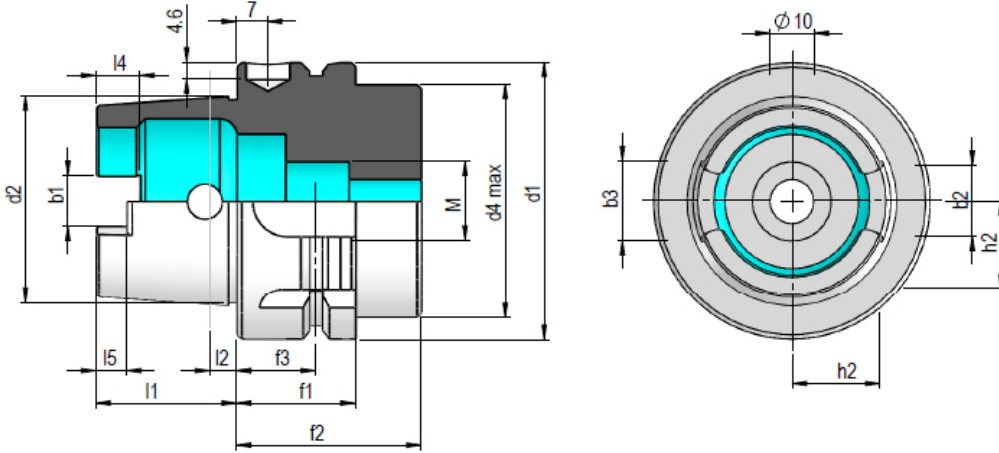

Kegel 1:10

d ₁	d ₂	d ₄	l ₁	l ₂	l ₄	l ₅	M	f ₁	f ₂	f ₃	b ₁	b ₂	b ₃	h ₂
32	24	26	16	3,2	5,0	3,0	M10x1	20	35	16	7,05	7	9	9,5
40	30	34	20	4,0	6,0	3,5	M12x1	20	35	16	8,05	9	11	12
50	38	42	25	5,0	7,5	4,5	M16x1	26	42	18	10,54	12	14	15,5
63	48	53	32	6,3	10,0	6,0	M18x1	26	42	18	12,54	16	18	20
80	60	67	40	8,0	12,0	8,0	M20x1,5	26	42	18	16,04	18	20	25
100	75	85	50	10,0	15,0	10,0	M24x1,5	29	45	20	20,02	20	22	31,5

Material : Case hardened steel, tensile strength in the core min. 950 N/mm²
Technical Info : Case hardened HRC 58 ± 2 depth of case 0,6 mm ± 0,2 mm, black - finish
Accuracy : Cone angle AT3
 Surface roughness of cone max 0,001 mm

Werkstoff : Legierter Einsatzstahl mit einer Zugfestigkeit im Kern von min. 950 N/mm²
Ausführung : Einsatzgehärtet HRC 58 ± 2 Härtetiefe 0,6 mm ± 0,2 mm, brüniert
Genauigkeit : Kegelwinkel - Toleranzqualität AT3
 Oberflächenrauigkeit des Kegels max. 0,001 mm

Malzeme : Alaşımlı semente çeliği çekme mukavemeti min. 950 N/mm²
Teknik Özelliği : Sertlik HRC 58 ± 2 sertlik derinliği 0,6 mm ± 0,2 mm, karartılmış
Hassasiyeti : Konik açı tolerans kalitesi AT3
 Konik yüzey kalitesi max. 0,001 mm

OZ Collet Chuck DIN 6391

HSK-A (DIN 69893)

Form
A

G6.3
20.000 RPM



OZ Spannanzengfutter DIN 6391

OZ Pens Başlığı DIN 6391

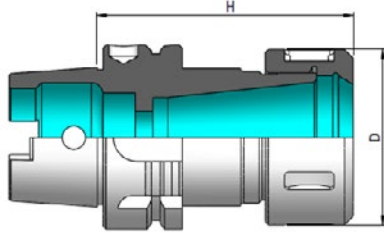

Order No. Bestell-Nr. Sipariş No.	Description Bezeichnung Açıklama	H	Capacity Spannbereich Kapasite	D
63A.01.216	HSK63A DIN69893 H100 OZ16	100	2-16	43
63A.01.225	HSK63A DIN69893 H100 OZ25	100	2-25	60
63A.01.232	HSK63A DIN69893 H120 OZ32	120	4-32	72
100A.01.216	HSK100A DIN69893 H100 OZ16	110	2-16	43
100A.01.225	HSK100A DIN69893 H120 OZ25	120	2-25	60
100A.01.232	HSK100A DIN69893 H130 OZ32	130	4-32	72



Collet
Spannzange
Pens

129



Clamping Nut
Spannmutter
Kapak

138



Wrench
Hakenschlüssel
Ay Anahtarı

142

ER Collet Chuck DIN 6499

HSK-A (DIN 69893)

Form
AG6.3
20.000 RPM

ER Spannzangenfutter DIN 6499

ER Pens Başığı DIN 6499

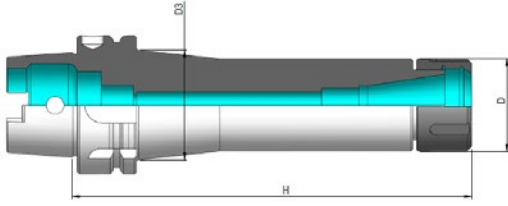

Order No. Bestell-Nr. Sipariş No.	Description Bezeichnung Açıklama	H	Capacity Spannbereich Kapasite	D	D3
63A.02.116	HSK63A DIN69893 H 75 ER25	75	2-16	42	-
63A.02.120	HSK63A DIN69893 H 75 ER32	75	2-20	50	-
63A.02.126	HSK63A DIN69893 H 80 ER40	80	3-26	63	-
63A.02.210	HSK63A DIN69893 H100 ER16	100	1-10	32	-
63A.02.213	HSK63A DIN69893 H100 ER20	100	1-13	35	-
63A.02.216	HSK63A DIN69893 H100 ER25	100	2-16	42	-
63A.02.220	HSK63A DIN69893 H100 ER32	100	2-20	50	-
63A.02.226	HSK63A DIN69893 H100 ER40	100	3-26	63	-
63A.02.310	HSK63A DIN69893 H130 ER16	130	1-10	32	-
63A.02.316	HSK63A DIN69893 H130 ER25	130	2-16	42	-
63A.02.320	HSK63A DIN69893 H130 ER32	130	2-20	50	-
63A.02.326	HSK63A DIN69893 H130 ER40	130	3-26	63	-
63A.02.410	HSK63A DIN69893 H160 ER16	160	1-10	32	32
63A.02.416	HSK63A DIN69893 H160 ER25	160	2-16	42	-
63A.02.420	HSK63A DIN69893 H160 ER32	160	2-20	50	-
63A.02.426	HSK63A DIN69893 H160 ER40	160	3-26	63	-
63A.02.510	HSK63A DIN69893 H200 ER16	200	1-10	32	32
63A.02.516	HSK63A DIN69893 H200 ER25	200	2-16	42	42
63A.02.520	HSK63A DIN69893 H200 ER32	200	2-20	50	50
63A.02.526	HSK63A DIN69893 H200 ER40	200	3-26	63	63

Collet
Spannzange
Pens

128

Clamping Nut
Spannmutter
Kapak

138

Wrench
Spannschlüssel
Ay Anahtarı

142

TOOLING TECHNOLOGY

Gisstec®



ER Collet Chuck DIN 6499

HSK-A (DIN 69893)

Form
A

G6.3
20.000 RPM



ER Spannanzengfutter DIN 6499

ER Pens Başlığı DIN 6499

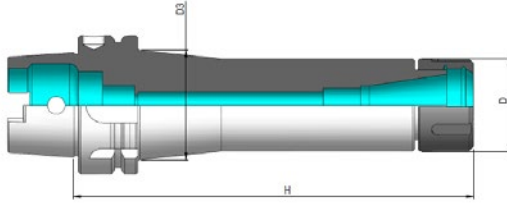

Order No. Bestell-Nr. Sipariş No.	Description Bezeichnung Açıklama	H	Capacity Spannbereich Kapasite	D	D3
100A.02.210	HSK100A DIN69893 H100 ER16	100	1-10	32	-
100A.02.216	HSK100A DIN69893 H100 ER25	100	2-16	42	-
100A.02.220	HSK100A DIN69893 H100 ER32	100	2-20	50	-
100A.02.226	HSK100A DIN69893 H100 ER40	100	3-26	63	-
100A.02.410	HSK100A DIN69893 H160 ER16	160	1-10	32	32
100A.02.416	HSK100A DIN69893 H160 ER25	160	2-16	42	42
100A.02.420	HSK100A DIN69893 H160 ER32	160	2-20	50	50
100A.02.426	HSK100A DIN69893 H160 ER40	160	3-26	63	63



Collet
Spannzange
Pens

128



Clamping Nut
Spannmutter
Kapak

138



Wrench
Spannschlüssel
Ay Anahtarı

142

ER Mini Collet Chuck DIN 6499

HSK-A (DIN 69893)

Form
A

G6.3
20.000 RPM



Spannzangenfutter ER Mini DIN 6499

ER Mini Pens Başlığı DIN 6499

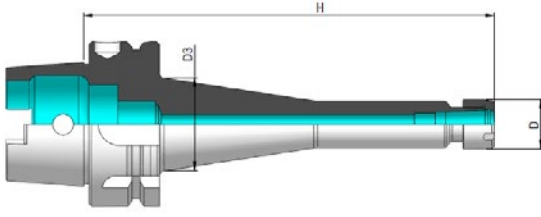

Order No. Bestell-Nr. Sipariş No.	Description Bezeichnung Açıklama	H	Capacity Spannbereich Kapasite	D	D3
63A.2M.207	HSK63A DIN69893 H100 ER11Mini	100	1-7	16	19
63A.2M.210	HSK63A DIN69893 H100 ER16Mini	100	1-10	22	25
63A.2M.213	HSK63A DIN69893 H100 ER20Mini	100	1-13	28	31
63A.2M.407	HSK63A DIN69893 H160 ER11Mini	160	1-7	16	23
63A.2M.410	HSK63A DIN69893 H160 ER16Mini	160	1-10	22	28
63A.2M.413	HSK63A DIN69893 H160 ER20Mini	160	1-13	28	35



Collet
Spannzange
Pens

128



Clamping Nut Mini
Spannmutter Mini
Kapak Mini

139



Wrench for Mini
Spannschlüssel für Mini
Ay Anahtarları Mini

143

Ultra Precise Collet Chuck

HSK-A (DIN 69893)

Form
A

G2.5
20.000 RPM



Ultra-Präzises Spannzangenfutter

Ultra Hassas Pens Başlığı

Clamping Power / Spannkraft / Sıkma Kuvveti **+ 25%**

Runout / Rundlauf / Salgı **0,003 mm**

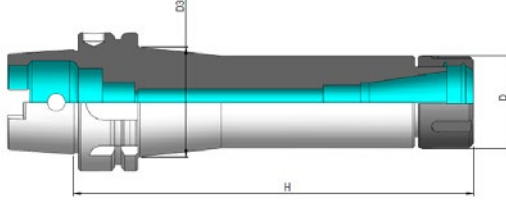

Order No. Bestell-Nr. Sipariş No.	Description Bezeichnung Açıklama	H	Capacity Spannbereich Kapasite	D
63A.2U.210	HSK 63A DIN69893 H100 ER16	100	1-10	30
63A.2U.216	HSK 63A DIN69893 H100 ER25	100	1-16	40
63A.2U.220	HSK 63A DIN69893 H100 ER32	100	1-20	50
63A.2U.416	HSK 63A DIN69893 H160 ER25	160	1-16	40
63A.2U.420	HSK 63A DIN69893 H160 ER32	160	1-20	50
100A.2U.220	HSK 100A DIN69893 H100 ER32	100	1-20	50
100A.2U.410	HSK 100A DIN69893 H160 ER16	160	1-10	30
100A.2U.420	HSK 100A DIN69893 H160 ER32	160	1-20	50



Milling Chuck

HSK-A (DIN 69893)

Form
A

G6.3
12.000 RPM



Kraftspannfutter

Bilyalı Pens Başlığı

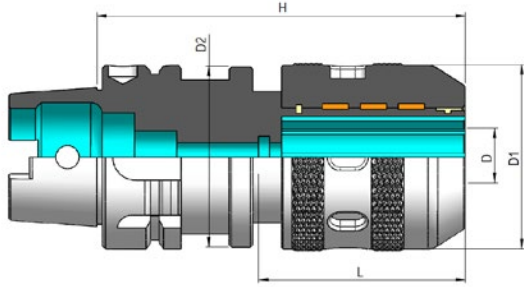

Order No. Bestell-Nr. Sipariş No.	Description Bezeichnung Açıklama	H	D	D1	D2	L
63A.03.120	HSK 63A DIN69893 H85 6-20	85	20	46	47	60
63A.03.232	HSK 63A DIN69893 H110 6-32	110	32	62	63	80
100A.03.220	HSK100A DIN69893 H105 6-20	105	20	46	47	60
100A.03.232	HSK100A DIN69893 H115 6-32	115	32	62	63	80



Collet
Spannzange
Pens

136



Wrench
Hakenschlüssel
Ay Anahtarı

142

Ultra Clamp

HSK-A (DIN 69893)

Form
A

G2.5
20.000 RPM



Ultra Clamp

Ultra Clamp

Clamping Power / Spannkraft / Sıkma Kuvveti **800 Nm**

Runout / Rundlauf / Salgı **0,003 mm**

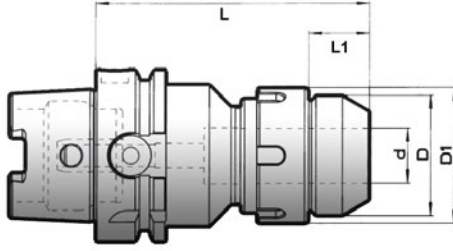

Order No. Bestell-Nr. Sipariş No.	Description Bezeichnung Açıklama	d	H	D1	D	L1	Nm
63A.3U.106	HSK63A Ø6 x 74	6	74	32	26	11	150
63A.3U.108	HSK63A Ø8 x 75	8	75	32	27	11	180
63A.3U.110	HSK63A Ø10 x 79	10	79	37	32	13	320
63A.3U.112	HSK63A Ø12 x 85	12	85	37	35	20	380
63A.3U.116	HSK63A Ø16 x 88	16	88	44	40	21	400
63A.3U.120	HSK63A Ø20 x 90	20	90	49	46	23	520
63A.3U.125	HSK63A Ø25 x 97	25	97	54	52	26	550
63A.3U.132	HSK63A Ø32 x 105	32	105	68	67	33	800
63A.3U.420	HSK63A Ø20 x 150	20	150	49	46	23	520
63A.3U.432	HSK63A Ø32 x 150	32	150	68	67	33	800
100A.3U.120	HSK100A Ø20 x 90	20	90	49	46	23	520
100A.3U.132	HSK100A Ø32 x 105	32	103	68	67	33	800

Suitable for cylindrical shaft
and weldon tools

Vibration dampening

Axial tool adjustment

Coolant through up to 100 bar

Geeignet für Werkzeuge mit
zylindrischem Schaft und Weldon

Vibrationsdämpfung

Längeneinstellung

IK bis 100 bar

Silindirik ve veldon şaftlı
kesiciler için

Vibrasyon sönümlenme

Kesici boy ayarı

100 bara kadar içten su verme



Collet
Spannzange
Pens

136



Wrench
Hakenschlüssel
Ay Anahtar

142

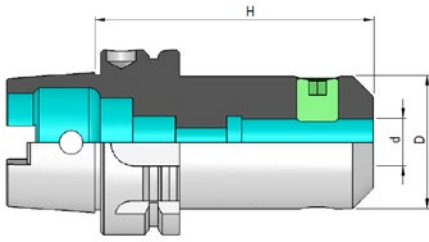

Order No. Bestell-Nr. Sipariş No.	Description Bezeichnung Açıklama	H	D	d
63A.04.106	HSK63A DIN69893 H 65 d 6	65	25	6
63A.04.108	HSK63A DIN69893 H 65 d 8	65	28	8
63A.04.110	HSK63A DIN69893 H 65 d10	65	35	10
63A.04.112	HSK63A DIN69893 H 80 d12	80	42	12
63A.04.114	HSK63A DIN69893 H 80 d14	80	44	14
63A.04.116	HSK63A DIN69893 H 80 d16	80	48	16
63A.04.118	HSK63A DIN69893 H 80 d18	80	50	18
63A.04.120	HSK63A DIN69893 H 80 d20	80	52	20
63A.04.125	HSK63A DIN69893 H110 d25	110	65	25
63A.04.132	HSK63A DIN69893 H110 d32	110	72	32
63A.04.140	HSK63A DIN69893 H125 d40	125	80	40
63A.04.206	HSK63A DIN69893 H100 d 6	100	25	6
63A.04.208	HSK63A DIN69893 H100 d 8	100	28	8
63A.04.210	HSK63A DIN69893 H100 d10	100	35	10
63A.04.212	HSK63A DIN69893 H100 d12	100	42	12
63A.04.214	HSK63A DIN69893 H100 d14	100	44	14
63A.04.216	HSK63A DIN69893 H100 d16	100	48	16
63A.04.218	HSK63A DIN69893 H100 d18	100	50	18
63A.04.220	HSK63A DIN69893 H100 d20	100	52	20

Clamping Screw
Spannschraube
Sıkma Civatası

End Mill Holder DIN 6359 / 1835 B

HSK-A (DIN 69893)

Form
A

G6.3
20.000 RPM



Fräseraufnahme DIN 6359 / 1835 B

Veldon Tutucu DIN 6359 / 1835 B

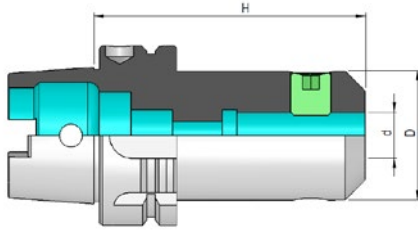

Order No. Bestell-Nr. Sipariş No.	Description Bezeichnung Açıklama	H	D	d
63A.04.406	HSK63A DIN69893 H160 d 6	160	25	6
63A.04.408	HSK63A DIN69893 H160 d 8	160	28	8
63A.04.410	HSK63A DIN69893 H160 d10	160	35	10
63A.04.412	HSK63A DIN69893 H160 d12	160	42	12
63A.04.414	HSK63A DIN69893 H160 d14	160	44	14
63A.04.416	HSK63A DIN69893 H160 d16	160	48	16
63A.04.418	HSK63A DIN69893 H160 d18	160	50	18
63A.04.420	HSK63A DIN69893 H160 d20	160	52	20
63A.04.425	HSK63A DIN69893 H160 d25	160	65	25
63A.04.432	HSK63A DIN69893 H160 d32	160	72	32
63A.04.440	HSK63A DIN69893 H160 d40	160	80	40



Clamping Screw
Spannschraube
Sikma Civatası

148

End Mill Holder DIN 6359 / 1835 B

HSK-A (DIN 69893)

Form
AG6.3
20.000 RPM

Fräseraufnahme DIN 6359 / 1835 B

Veldon Tutucu DIN 6359 / 1835 B

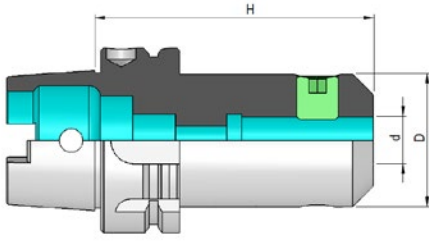

Order No. Bestell-Nr. Sipariş No.	Description Bezeichnung Açıklama	H	D	d
100A.04.106	HSK100A DIN69893 H 65 d 6	80	25	6
100A.04.108	HSK100A DIN69893 H 80 d 8	80	28	8
100A.04.110	HSK100A DIN69893 H 80 d10	80	35	10
100A.04.112	HSK100A DIN69893 H 80 d12	80	42	12
100A.04.114	HSK100A DIN69893 H 80 d14	80	44	14
100A.04.116	HSK100A DIN69893 H100 d16	100	48	16
100A.04.118	HSK100A DIN69893 H100 d18	100	50	18
100A.04.120	HSK100A DIN69893 H100 d20	100	52	20
100A.04.125	HSK100A DIN69893 H100 d25	100	65	25
100A.04.132	HSK100A DIN69893 H100 d32	100	72	32
100A.04.140	HSK100A DIN69893 H105 d40	105	80	40
100A.04.406	HSK100A DIN69893 H160 d 6	160	25	6
100A.04.408	HSK100A DIN69893 H160 d 8	160	28	8
100A.04.410	HSK100A DIN69893 H160 d10	160	35	10
100A.04.412	HSK100A DIN69893 H160 d12	160	42	12
100A.04.414	HSK100A DIN69893 H160 d14	160	44	14
100A.04.416	HSK100A DIN69893 H160 d16	160	48	16
100A.04.418	HSK100A DIN69893 H160 d18	160	50	18
100A.04.420	HSK100A DIN69893 H160 d20	160	52	20
100A.04.425	HSK100A DIN69893 H160 d25	160	65	25
100A.04.432	HSK100A DIN69893 H160 d32	160	72	32
100A.04.440	HSK100A DIN69893 H160 d40	160	80	40

Clamping Screw
Spanschraube
Sıkma Civatası

148

TOOLING TECHNOLOGY

Gisstec®



End Mill Holder with Coolant Channel DIN 6359 / 1835 B HSK-A (DIN 69893)

Form
A

G6.3
20.000 RPM



Fräseraufnahme mit Kühlkanal DIN 6359 / 1835 B

Veldon Tutucu Alından Soğutmalı DIN 6359 / 1835 B

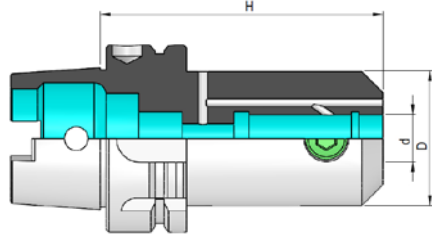

Order No. Bestell-Nr. Sipariş No.	Description Bezeichnung Açıklama	H	D	d
63A.4K.106	HSK63A DIN69893 H 65 d 6	65	25	6
63A.4K.108	HSK63A DIN69893 H 65 d 8	65	28	8
63A.4K.110	HSK63A DIN69893 H 65 d10	65	35	10
63A.4K.112	HSK63A DIN69893 H 80 d12	80	42	12
63A.4K.114	HSK63A DIN69893 H 80 d14	80	44	14
63A.4K.116	HSK63A DIN69893 H 80 d16	80	48	16
63A.4K.118	HSK63A DIN69893 H 80 d18	80	50	18
63A.4K.120	HSK63A DIN69893 H 80 d20	80	52	20
63A.4K.125	HSK63A DIN69893 H110 d25	110	65	25
63A.4K.132	HSK63A DIN69893 H110 d32	110	72	32
63A.4K.140	HSK63A DIN69893 H125 d40	125	80	40
100A.4K.106	HSK100A DIN69893 H 65 d 6	80	25	6
100A.4K.108	HSK100A DIN69893 H 80 d 8	80	28	8
100A.4K.110	HSK100A DIN69893 H 80 d10	80	35	10
100A.4K.112	HSK100A DIN69893 H 80 d12	80	42	12
100A.4K.114	HSK100A DIN69893 H 80 d14	80	44	14
100A.4K.116	HSK100A DIN69893 H100 d16	100	48	16
100A.4K.118	HSK100A DIN69893 H100 d18	100	50	18
100A.4K.120	HSK100A DIN69893 H100 d20	100	52	20
100A.4K.125	HSK100A DIN69893 H100 d25	100	65	25
100A.4K.132	HSK100A DIN69893 H100 d32	100	72	32
100A.4K.140	HSK100A DIN69893 H105 d40	105	80	40



Clamping Screw
Spannschraube
Sikma Civatası

End Mill Holder Whistle Notch DIN 6359 / 1835 E

HSK-A (DIN 69893)

Form
AG6.3
20.000 RPM

Fräseraufnahme Whistle Notch DIN 6359 / 1835 E

Veldon Tutucu, 2° Açılı DIN 6359 / 1835 E

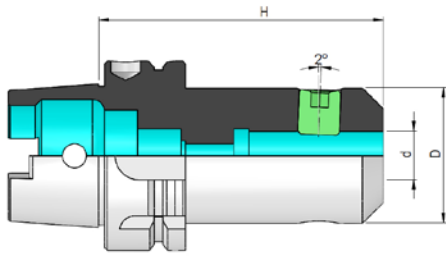

Order No. Bestell-Nr. Sipariş No.	Description Bezeichnung Açıklama	H	D	d
63A.05.106	HSK63A DIN69893 H 80 d 6	80	25	6
63A.05.108	HSK63A DIN69893 H 80 d 8	80	28	8
63A.05.110	HSK63A DIN69893 H 80 d10	80	35	10
63A.05.112	HSK63A DIN69893 H 90 d12	90	42	12
63A.05.114	HSK63A DIN69893 H 90 d14	90	44	14
63A.05.116	HSK63A DIN69893 H100 d16	100	48	16
63A.05.118	HSK63A DIN69893 H100 d18	100	50	18
63A.05.120	HSK63A DIN69893 H100 d20	100	52	20
63A.05.125	HSK63A DIN69893 H110 d25	110	65	25
63A.05.132	HSK63A DIN69893 H110 d32	110	72	32
100A.05.106	HSK100A DIN69893 H 80 d 6	90	25	6
100A.05.108	HSK100A DIN69893 H 90 d 8	90	28	8
100A.05.110	HSK100A DIN69893 H 90 d10	90	35	10
100A.05.112	HSK100A DIN69893 H100 d12	100	42	12
100A.05.114	HSK100A DIN69893 H100 d14	100	44	14
100A.05.116	HSK100A DIN69893 H100 d16	100	48	16
100A.05.118	HSK100A DIN69893 H100 d18	100	50	18
100A.05.120	HSK100A DIN69893 H110 d20	110	52	20
100A.05.125	HSK100A DIN69893 H120 d25	120	65	25
100A.05.132	HSK100A DIN69893 H120 d32	120	72	32
100A.05.140	HSK100A DIN69893 H120 d40	120	80	40

Clamping Screw
Spannschraube
Sıkma Civatası

148

TOOLING TECHNOLOGY

Gisstec®



Morse Taper Adaptor DIN 6383

HSK-A (DIN 69893)

Form
A

G6.3
20.000 RPM



Zwischenhülse mit Austreibl. DIN 6383

Mors Adaptörü DIN 6383

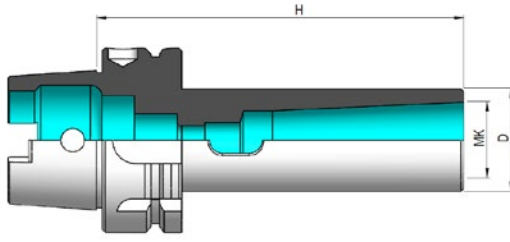

Order No. Bestell-Nr. Sipariş No.	Description Bezeichnung Açıklama	H	MK	D
63A.07.101	HSK63A DIN69893 H100 MK1	100	1	25
63A.07.102	HSK63A DIN69893 H120 MK2	120	2	32
63A.07.103	HSK63A DIN69893 H140 MK3	140	3	40
63A.07.104	HSK63A DIN69893 H160 MK4	160	4	48
100A.07.101	HSK100A DIN69893 H100 MK1	100	1	25
100A.07.102	HSK100A DIN69893 H120 MK2	120	2	32
100A.07.103	HSK100A DIN69893 H150 MK3	150	3	40
100A.07.104	HSK100A DIN69893 H170 MK4	170	4	48
100A.07.105	HSK100A DIN69893 H200 MK5	200	5	63

Morse Taper Adaptor with Thread DIN 6364

HSK-A (DIN 69893)

Form
A

G6.3
20.000 RPM



Zwischenhülse mit Anzugsg. DIN 6364

Çektirmeli Mors Adaptörü DIN 6364

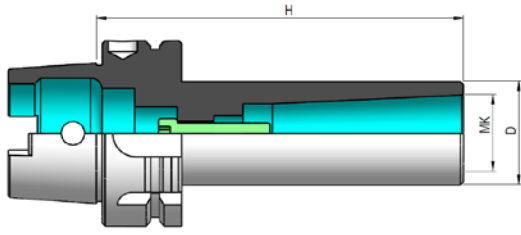

Order No. Bestell-Nr. Sipariş No.	Description Bezeichnung Açıklama	H	MK	D
63A.08.101	HSK63A DIN69893 H100 CMK1	100	1	25
63A.08.102	HSK63A DIN69893 H120 CMK2	120	2	32
63A.08.103	HSK63A DIN69893 H140 CMK3	140	3	40
63A.08.104	HSK63A DIN69893 H160 CMK4	160	4	48
100A.08.101	HSK100A DIN69893 H100 CMK1	110	1	25
100A.08.102	HSK100A DIN69893 H120 CMK2	120	2	32
100A.08.103	HSK100A DIN69893 H140 CMK3	150	3	40
100A.08.104	HSK100A DIN69893 H160 CMK4	170	4	48
100A.08.105	HSK100A DIN69893 H200 CMK5	200	5	63

Combi Shell Mill Holder DIN 6358

HSK-A (DIN 69893)

Form
A

G6.3
20.000 RPM



Kombi-Aufsteckfräserdorn DIN 6358

Kombine Malafa DIN 6358

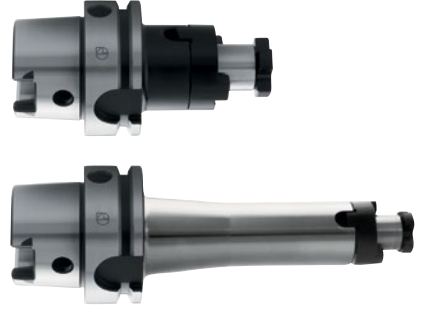
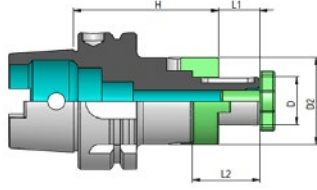

Order No. Bestell-Nr. Sipariş No.	Description Bezeichnung Açıklama	H	D	D2	L1	L2
63A.10.116	HSK63A DIN69893 H 60 D16	60	16	32	17	27
63A.10.122	HSK63A DIN69893 H 60 D22	60	22	40	19	31
63A.10.127	HSK63A DIN69893 H 60 D27	60	27	48	21	33
63A.10.132	HSK63A DIN69893 H 60 D32	60	32	58	24	38
63A.10.140	HSK63A DIN69893 H 70 D40	70	40	70	27	41
63A.10.216	HSK63A DIN69893 H100 D16	100	16	32	17	27
63A.10.222	HSK63A DIN69893 H100 D22	100	22	40	19	31
63A.10.227	HSK63A DIN69893 H100 D27	100	27	48	21	33
63A.10.232	HSK63A DIN69893 H100 D32	100	32	58	24	38
63A.10.240	HSK63A DIN69893 H100 D40	100	40	70	27	41
63A.10.416	HSK63A DIN69893 H160 D16	160	16	32	17	27
63A.10.422	HSK63A DIN69893 H160 D22	160	22	40	19	31
63A.10.427	HSK63A DIN69893 H160 D27	160	27	48	21	33
63A.10.432	HSK63A DIN69893 H160 D32	160	32	58	24	38
63A.10.440	HSK63A DIN69893 H160 D40	160	40	70	27	41
100A.10.116	HSK100A DIN69893 H 60 D16	60	16	32	17	27
100A.10.122	HSK100A DIN69893 H 60 D22	60	22	40	19	31
100A.10.127	HSK100A DIN69893 H 60 D27	60	27	48	21	33
100A.10.132	HSK100A DIN69893 H 60 D32	60	32	58	24	38
100A.10.140	HSK100A DIN69893 H 70 D40	70	40	70	27	41
100A.10.216	HSK100A DIN69893 H100 D16	100	16	32	17	27
100A.10.222	HSK100A DIN69893 H100 D22	100	22	40	19	31
100A.10.227	HSK100A DIN69893 H100 D27	100	27	48	21	33
100A.10.232	HSK100A DIN69893 H100 D32	100	32	58	24	38
100A.10.240	HSK100A DIN69893 H100 D40	100	40	70	27	41
100A.10.416	HSK100A DIN69893 H160 D16	160	16	32	17	27
100A.10.422	HSK100A DIN69893 H160 D22	160	22	40	19	31
100A.10.427	HSK100A DIN69893 H160 D27	160	27	48	21	33
100A.10.432	HSK100A DIN69893 H160 D32	160	32	58	24	38
100A.10.440	HSK100A DIN69893 H160 D40	160	40	70	27	41



Clutch Drive Ring
Mitnehmerring
Tırnaklı Pul

152



Draw-in Bolt
Fräseranzugsschraube
Kelebek Civata

152



Wrench
Spannschlüssel
Anahtar

152



Shell Mill Holder DIN 6357

HSK-A (DIN 69893)

Form
A

G6.3
20.000 RPM



Messerkopfaufnahme DIN 6357

Alın Kamalı Malafa DIN 6357

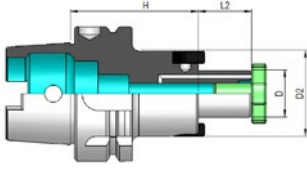

Order No. Bestell-Nr. Sipariş No.	Description Bezeichnung Açıklama	H	D	D2	L2
63A.11.116	HSK63A DIN69893 H 50 D16	50	16	38	17
63A.11.122	HSK63A DIN69893 H 50 D22	50	22	48	19
63A.11.127	HSK63A DIN69893 H 60 D27	60	27	58	21
63A.11.132	HSK63A DIN69893 H 60 D32	60	32	78	24
63A.11.140	HSK63A DIN69893 H 60 D40	60	40	88	27
63A.11.216	HSK63A DIN69893 H100 D16	100	16	38	17
63A.11.222	HSK63A DIN69893 H100 D22	100	22	48	19
63A.11.227	HSK63A DIN69893 H100 D27	100	27	58	21
63A.11.232	HSK63A DIN69893 H100 D32	100	32	78	24
63A.11.240	HSK63A DIN69893 H100 D40	100	40	88	27
63A.11.416	HSK63A DIN69893 H160 D16	160	16	38	17
63A.11.422	HSK63A DIN69893 H160 D22	160	22	48	19
63A.11.427	HSK63A DIN69893 H160 D27	160	27	58	21
63A.11.432	HSK63A DIN69893 H160 D32	160	32	78	24
63A.11.440	HSK63A DIN69893 H160 D40	160	40	88	27



Draw-in Bolt
Fräseranzugsschraube
Kelebek Civata

152



Wrench
Spannschlüssel
Anahtar

152

Shell Mill Holder DIN 6357

HSK-A (DIN 69893)

Form
A

G6.3
20.000 RPM



Messerkopfaufnahme DIN 6357

Alın Kamalı Malafa DIN 6357

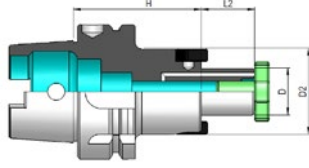

Order No. Bestell-Nr. Sipariş No.	Description Bezeichnung Açıklama	H	D	D2	L2
100A.11.116	HSK100A DIN69893 H50 D16	50	16	38	17
100A.11.122	HSK100A DIN69893 H50 D22	50	22	48	19
100A.11.127	HSK100A DIN69893 H50 D27	50	27	58	21
100A.11.132	HSK100A DIN69893 H50 D32	50	32	78	24
100A.11.140	HSK100A DIN69893 H60 D40	60	40	88	27
100A.11.216	HSK100A DIN69893 H100 D16	100	16	38	17
100A.11.222	HSK100A DIN69893 H100 D22	100	22	48	19
100A.11.227	HSK100A DIN69893 H100 D27	100	27	58	21
100A.11.232	HSK100A DIN69893 H100 D32	100	32	78	24
100A.11.240	HSK100A DIN69893 H100 D40	100	40	88	27
100A.11.416	HSK100A DIN69893 H160 D16	160	16	38	17
100A.11.422	HSK100A DIN69893 H160 D22	160	22	48	19
100A.11.427	HSK100A DIN69893 H160 D27	160	27	58	21
100A.11.432	HSK100A DIN69893 H160 D32	160	32	78	24
100A.11.440	HSK100A DIN69893 H160 D40	160	40	88	27



Draw-in Bolt
Fräseranzugsschraube
Kelebek Civata

152



Wrench
Spannschlüssel
Anahtar

152



Fräserdorn für Aufschraubfräser

Vidalı Freze Takımı

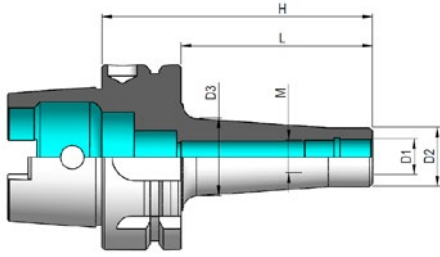

Order No. Bestell-Nr. Sipariş No.	Description Bezeichnung Açıklama	H	D1	D2	D3	L	M
63A.12.108	HSK63A DIN69893 M 8x59	59	8,5	13	15	33	M 8
63A.12.110	HSK63A DIN69893 M10x59	59	10,5	18	19,5	33	M10
63A.12.112	HSK63A DIN69893 M12x59	59	12,5	21	24	33	M12
63A.12.116	HSK63A DIN69893 M16x59	59	17	29	34	33	M16
63A.12.208	HSK63A DIN69893 M 8x84	84	8,5	13	23	58	M 8
63A.12.210	HSK63A DIN69893 M10x84	84	10,5	18	25	58	M10
63A.12.212	HSK63A DIN69893 M12x84	84	12,5	21	24	58	M12
63A.12.216	HSK63A DIN69893 M16x84	84	17	29	34	58	M16
63A.12.308	HSK63A DIN69893 M 8x109	109	8,5	13	23	83	M 8
63A.12.310	HSK63A DIN69893 M10x109	109	10,5	18	28	83	M10
63A.12.312	HSK63A DIN69893 M12x109	109	12,5	21	31	83	M12
63A.12.316	HSK63A DIN69893 M16x109	109	17	29	34	83	M16
63A.12.408	HSK63A DIN69893 M 8x134	134	8,5	13	25	108	M 8
63A.12.410	HSK63A DIN69893 M10x134	134	10,5	18	28	108	M10
63A.12.412	HSK63A DIN69893 M12x134	134	12,5	21	31	108	M12
63A.12.416	HSK63A DIN69893 M16x134	134	17	29	39	108	M16
63A.12.510	HSK63A DIN69893 M10x159	159	10,5	18	31	133	M10
63A.12.512	HSK63A DIN69893 M12x159	159	12,5	21	34	133	M12
63A.12.516	HSK63A DIN69893 M16x159	159	17	29	39	133	M16
63A.12.612	HSK63A DIN69893 M12x184	184	12,5	21	34	158	M12
63A.12.616	HSK63A DIN69893 M16x184	184	17	29	39	158	M16
63A.12.712	HSK63A DIN69893 M12x209	209	12,5	21	42	183	M12
63A.12.716	HSK63A DIN69893 M16x209	209	17	29	42	183	M16

Milling Cutter Arbor

HSK-A (DIN 69893)

Form
A

G2.5
20.000 RPM



Fräserdorn für Aufschraubfräser

Vidalı Freze Takımı

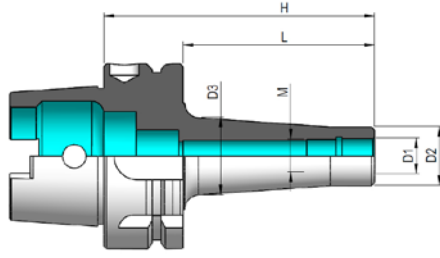

Order No. Bestell-Nr. Sipariş No.	Description Bezeichnung Açıklama	H	D1	D2	D3	L	M
100A.12.212	HSK100A DIN69893 M12X 84	87	12,5	21	24	58	12
100A.12.216	HSK100A DIN69893 M16X 87	87	17	29	34	58	16
100A.12.312	HSK100A DIN69893 M12X137	137	12,5	21	31	108	12
100A.12.316	HSK100A DIN69893 M16X137	137	17	29	34	108	16
100A.12.412	HSK100A DIN69893 M12X187	187	12,5	21	31	158	12
100A.12.416	HSK100A DIN69893 M16X187	187	17	29	39	158	16
100A.12.516	HSK100A DIN69893 M16X237	237	17	29	39	208	16

NC-Drill Chuck for Left and Right Rotation

Form
A

G6.3
12.000 RPM



Kurzbohrfutter für Links- und Rechtslauf

NC-Mandren Malafası, Sağ-Sol Dönüşlü

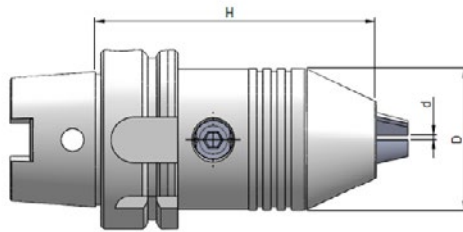

Order No. Bestell-Nr. Sipariş No.	Description Bezeichnung Açıklama	H	D	d
63A.15.113	HSK63A DIN69893 H123,5 d13	123,5	50	1-13
63A.15.116	HSK63A DIN69893 H129 d16	129	50	2,5-16
100A.15.113	HSK100A DIN69893 H130 d13	130	50	1-13
100A.15.116	HSK100A DIN69893 H135,5 d16	135,5	50	2,5-16

Quick Change Tapping Chuck with Compensation

HSK-A (DIN 69893)

Form
A

Gewindeschneidfutter mit Längenausgleich

Kılavuz Çekme Başlığı, Kompanzeli

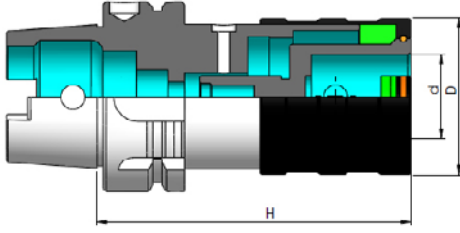

Order No. Bestell-Nr. Sipariş No.	Description Bezeichnung Açıklama	H	D	d	Capacity Spannbereich Kapasite	Compan. - Ext. Druck - zug Giriş - Çıkış
63A.16.112	HSK63A DIN69893 H 72 GR1	72	41	19	M3-M14	7,5-7,5
63A.16.120	HSK63A DIN69893 H110 GR2	110	60	31	M5-M24	10-10
100A.16.112	HSK100A DIN69893 H 80 GR1	80	41	19	M3-M14	7,5-7,5
100A.16.120	HSK100A DIN69893 H100 GR2	100	60	31	M5-M24	10-10

Synchro Quick Change Tapping Chuck

Form
A

Synchro-Gewindeschneidfutter

Senkronize Kılavuz Çekme Başlığı

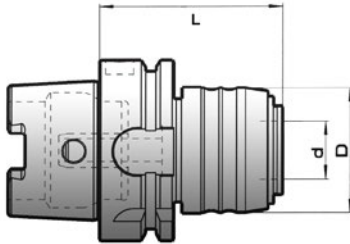

Order No. Bestell-Nr. Sipariş No.	Description Bezeichnung Açıklama	H	d	D	Capacity Spannbereich Kapasite	Compan. - Ext. Druck - zug Giriş - Çıkış
63A.26.112	HSK63A DIN69893 H64 ER16	64	20	43	M3-M12	0,2 - 1
63A.26.120	HSK63A DIN69893 H97 ER25	97	32	60	M6-M20	0,2 - 1
100A.26.112	HSK100A DIN69893 H70 ER16	70	20	43	M3-M12	0,2 - 1
100A.26.120	HSK100A DIN69893 H91 ER25	91	32	60	M6-M20	0,2 - 1
100A.26.133	HSK100A DIN69893 H115 ER40	115	50	87	M14-M33	0,2 - 1

Tapping Collet
Einsatz
Kılavuz Tutucu

144

Tap Adaptor for Synchro
Einsatz für Synchro
Senkronize için Kılavuz Tutucu

146

Blank Toolholder

HSK-A (DIN 69893)

Form
A



Bohrstangenrohling
Rohling, Özel Takım Amaçlı



Order No. Bestell-Nr. Sipariş No.	Description Bezeichnung Açıklama	H	D
63A.17.363	HSK63A DIN69893 Ø63 x 250	250	63
100A.17.397	HSK100A DIN69893 Ø97 x 315	315	97

Test Arbor

Form
A



Kontrolldorn
Kontrol Mastarı

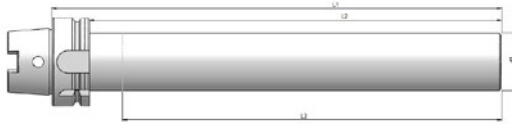

Order No. Bestell-Nr. Sipariş No.	Description Bezeichnung Açıklama	d1	l1	l2	l3	
63A.18.250	HSK63 A DIN69893 Ø40 x 250	40	250	224	200	0,003
100A.18.349	HSK100 A DIN69893 Ø50 x 349	50	349	320	300	0,003

Application : For acceptance tests for machine tools according to ISO Recommendation R-230

Verwendung : Zur Abnahme von Werkzeugmaschinen gemäß ISO-Empfehlungen R-230

Açıklama : Tezgah fener milinin ISO normu R-230'a göre uygunluğunu kontrol etmek için

Shrink Chuck

HSK-A (DIN 69893)

Form
AG2.5
25.000 RPM

Schrumpfutter

Isıtmalı Takım Tutucu

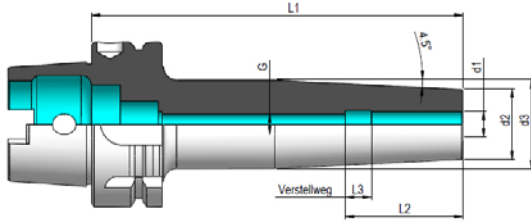

Order No. Bestell-Nr. Sipariş No.	HSK-A	d1	l1	d2	d3	l2	l3	g
63A.25.103	HSK63A	3	80	11	15	10	-	-
63A.25.104	HSK63A	4	80	14	22	20	5	M 3
63A.25.105	HSK63A	5	80	16	22	20	-	M 4
63A.25.106	HSK63A	6	80	21	27	36	10	M 5
63A.25.108	HSK63A	8	80	21	27	36	-	M 6
63A.25.110	HSK63A	10	85	24	32	42	-	M 8x1
63A.25.112	HSK63A	12	90	24	32	47	-	M10x1
63A.25.114	HSK63A	14	90	27	34	47	-	M10x1
63A.25.116	HSK63A	16	95	27	34	50	-	M12x1
63A.25.118	HSK63A	18	95	33	42	50	-	M12x1
63A.25.120	HSK63A	20	100	33	42	52	-	M16x1
63A.25.125	HSK63A	25	115	44	53	58	-	M16x1
63A.25.132	HSK63A	32	120	44	53	61	-	M16x1
63A.25.306	HSK63A	6	120	21	27	36	10	M 5
63A.25.308	HSK63A	8	120	21	27	36	-	M 6
63A.25.310	HSK63A	10	120	24	32	42	-	M 8x1
63A.25.312	HSK63A	12	120	24	32	47	-	M10x1
63A.25.314	HSK63A	14	120	27	34	47	-	M10x1
63A.25.316	HSK63A	16	120	27	34	50	-	M12x1
63A.25.318	HSK63A	18	120	33	42	50	-	M12x1
63A.25.320	HSK63A	20	120	33	42	52	-	M16x1

Application : For mounting of solid carbide and HSS cutters $\varnothing 6 - \varnothing 32$ with h6 tolerance and $\varnothing 3-4-5$ with h4 tolerance

Verwendung : Zum Spannen von HM - und HSS Werkzeugschaften $\varnothing 6-32$ mit h6-Toleranz und bei $\varnothing 3-4-5$ mit h4-Toleranz

Açıklama : Şaftı karbür ve HSS takımlar için şaft toleransı $\varnothing 6-32$ arası h6 $\varnothing 3-4-5$ arası h4 tolerans

Shrink Chuck

HSK-A (DIN 69893)

Form
A

G2.5
25.000 RPM



Schrumpfutter

Isıtmalı Takım Tutucu

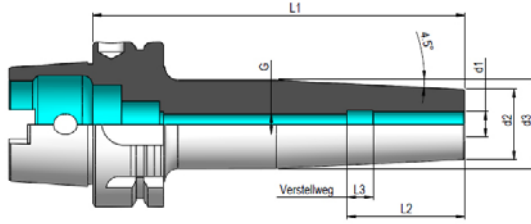

Order No. Bestell-Nr. Sipariş No.	HSK-A	d1	l1	d2	d3	l2	l3	g
63A.25.403	HSK63A	3	160	11	15	10	-	-
63A.25.404	HSK63A	4	160	14	22	20	5	M 3
63A.25.405	HSK63A	5	160	16	22	20	-	M 4
63A.25.406	HSK63A	6	160	21	27	36	10	M 5
63A.25.408	HSK63A	8	160	21	27	36	-	M 6
63A.25.410	HSK63A	10	160	24	32	42	-	M 8x1
63A.25.412	HSK63A	12	160	24	32	47	-	M10x1
63A.25.414	HSK63A	14	160	27	34	47	-	M10x1
63A.25.416	HSK63A	16	160	27	34	50	-	M12x1
63A.25.418	HSK63A	18	160	33	42	50	-	M12x1
63A.25.420	HSK63A	20	160	33	42	52	-	M16x1
63A.25.425	HSK63A	25	160	44	53	58	-	M16x1
100A.25.106	HSK100A	6	85	21	27	36	10	M 5
100A.25.108	HSK100A	8	85	21	27	36	-	M 6
100A.25.110	HSK100A	10	90	24	32	42	-	M 8x1
100A.25.112	HSK100A	12	95	24	32	47	-	M10x1
100A.25.114	HSK100A	14	95	27	34	47	-	M10x1
100A.25.116	HSK100A	16	100	27	34	50	-	M12x1
100A.25.118	HSK100A	18	100	33	42	50	-	M12x1
100A.25.120	HSK100A	20	105	33	42	52	-	M16x1
100A.25.125	HSK100A	25	120	44	53	56	-	M16x1
100A.25.132	HSK100A	32	120	44	53	62	-	M16x1

Application : For mounting of solid carbide and HSS cutters Ø6 - Ø32 with h6 tolerance and Ø3-4-5 with h4 tolerance

Verwendung : Zum Spannen von HM - und HSS Werkzeugschaften Ø6-Ø32 mit h6-Toleranz und bei Ø3-4-5 mit h4-Toleranz

Açıklama : Şaftı karbür ve HSS takımlar için şaft toleransı Ø6-Ø32 arası h6 Ø3-4-5 arası h4 tolerans

Shrink Chuck

HSK-A (DIN 69893)

Form
AG2.5
25.000 RPM

Schrumpfutter

Isıtmalı Takım Tutucu

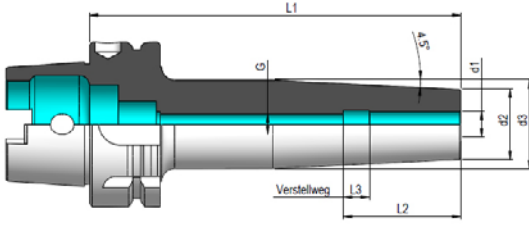

Order No. Bestell-Nr. Sipariş No.	HSK-A	d1	l1	d2	d3	l2	l3	g
100A.25.306	HSK100A	6	120	21	27	36	10	M 5
100A.25.308	HSK100A	8	120	21	27	36	-	M 6
100A.25.310	HSK100A	10	120	24	32	42	-	M 8x1
100A.25.312	HSK100A	12	120	24	32	47	-	M10x1
100A.25.314	HSK100A	14	120	27	34	47	-	M10x1
100A.25.316	HSK100A	16	120	27	34	50	-	M12x1
100A.25.318	HSK100A	18	120	33	42	50	-	M12x1
100A.25.320	HSK100A	20	120	33	42	52	-	M16x1
100A.25.406	HSK100A	6	160	21	27	36	10	M 5
100A.25.408	HSK100A	8	160	21	27	36	-	M 6
100A.25.410	HSK100A	10	160	24	32	42	-	M 8x1
100A.25.412	HSK100A	12	160	24	32	47	-	M10x1
100A.25.414	HSK100A	14	160	27	34	47	-	M10x1
100A.25.416	HSK100A	16	160	27	34	50	-	M12x1
100A.25.418	HSK100A	18	160	33	42	50	-	M12x1
100A.25.420	HSK100A	20	160	33	42	52	-	M16x1
100A.25.425	HSK100A	25	160	44	53	56	-	M16x1
100A.25.432	HSK100A	32	160	44	53	62	-	M16x1

Application : For mounting of solid carbide and HSS cutters Ø6 - Ø32 with h6 tolerance and Ø3-4-5 with h4 tolerance

Verwendung : Zum Spannen von HM - und HSS Werkzeugschaften Ø6-Ø32 mit h6-Toleranz und bei Ø3-4-5 mit h4-Toleranz

Açıklama : Şaftı karbür ve HSS takımlar için şaft toleransı Ø6-Ø32 arası h6 Ø3-4-5 arası h4 tolerans



Hydro - Dehnspannfutter

Hidrolik Takım Tutucu

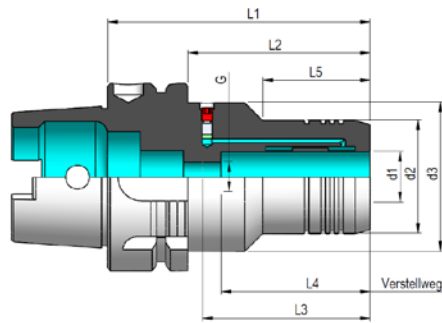

Order No. Bestell-Nr. Sipariş No.	HSK-A	d1	d2	d3	l1	l2	l3	l4	l5	g
63A.30.106	HSK 63	6	26	50	80	54	37	10	33	M 5
63A.30.108	HSK 63	8	28	50	80	54	37	10	33	M 6
63A.30.110	HSK 63	10	30	50	85	59	42	10	39	M 8x1
63A.30.112	HSK 63	12	32	50	90	64	47	10	44	M10x1
63A.30.114	HSK 63	14	34	50	90	64	47	10	46	M10x1
63A.30.116	HSK 63	16	38	50	95	69	52	10	52	M12x1
63A.30.118	HSK 63	18	40	50	95	69	52	10	52	M12x1
63A.30.120	HSK 63	20	42	50	100	74	52	10	58	M12x1
63A.30.125	HSK 63	25	50	50	120	94	58	10	94	M16x1
63A.30.132	HSK 63	32	60	50	125	99	62	10	83	M16x1
100A.30.106	HSK 100	6	26	50	85	56	37	10	29	M 5
100A.30.108	HSK 100	8	28	50	85	56	37	10	29	M 6
100A.30.110	HSK 100	10	30	50	90	61	42	10	35	M 8x1
100A.30.112	HSK 100	12	32	50	95	66	49	10	40	M10x1
100A.30.114	HSK 100	14	34	50	95	66	49	10	42	M10x1
100A.30.116	HSK 100	16	38	50	100	71	52	10	47	M12x1
100A.30.118	HSK 100	18	40	50	100	71	52	10	48	M12x1
100A.30.120	HSK 100	20	42	63	105	76	52	10	54	M12x1
100A.30.125	HSK 100	25	50	63	115	86	58	10	51	M16x1
100A.30.132	HSK 100	32	60	63	120	91	62	10	59	M16x1
100A.30.140	HSK 100	40	70	70	120	91	62	10	91	M16x1



Reduction Sleeve
Reduzierhülse
Hidrolik Pensi

