

SK (DIN 69871) AD/B

TOOLING SYSTEMS SPANNWERKZEUGE TAKIM TUTUCU SİSTEMLERİ



CONTENTS / INHALT / İÇİNDEKİLER

OZ Collet Chuck / OZ Spannanzangenfutter OZ Pens Başlığı	2
ER Collet Chuck / ER Spannanzangenfutter ER Pens Başlığı	3
UP Collet Chuck / Präzisionsspannanzangenfutter Ultra Hassas Pens Başlığı	6
Milling Chuck / Kraftspannfutter Bilyalı Pens Başlığı	7
Ultra Clamp / Ultra Clamp Ultra Clamp	8
End Mill Holder / Fräseraufnahme Veldon Tutucu	9
Morse Taper Adaptor / Zwischenhülse mit Austreiblappen Mors Adaptörü	16
Combi Shell Mill Holder / Kombi-Aufsteckfräserdom Kombine Malafa	18
Shell Mill Holder / Messerkopfaufnahme Alın Kamalı Malafa	20
Milling Cutter Arbor / Fräserdom für Aufschraubfräser Vidalı Freze Takımı	24
Drill Chuck Adaptor / Bohrfutteraufnahme Mandren Malafası	26
NC-Drill Chuck / Kurzbohrfutter NC-Mandren Malafası	27
Tapping Chuck / Gewindeschneidfutter Kılavuz Çekme Başlığı	28
Synchro Tapping Chuck / Synchro-Gewindeschneidfutter Senkronize Kılavuz Çekme Başlığı	28
Blank Toolholder / Bohrstangenrohling Rohling	29
Test Arbors / Kontrollidorn Kontrol Mastarı	29
Coolant Feeder / Kühlmittelzuführung Dıştan Soğutmalı Takım Tutucu	30
Shrink Chuck / Schrumpffutter Isıtmalı Takım Tutucu	31
Hydraulic Chuck / Hydro-Dehnspannfutter Hidrolik Takım Tutucu	34



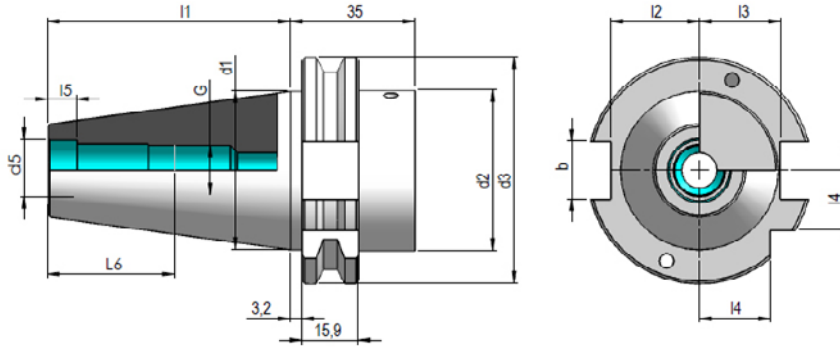

SK	d ₁	G	d ₅	d ₂	d ₃	l ₁	l ₂	l ₃	l ₄	l ₅	l ₆	d ₆	e	b
30	31,75	M12	13	45	50,00	47,80	16,4	19,0	15,0	5,5	24	M4	21	16,1
40	44,45	M16	17	50	63,55	68,40	22,8	25,0	18,5	8,2	32	M4	27	16,1
50	69,85	M24	25	80	97,50	101,75	35,5	37,7	30,0	11,5	47	M6	42	25,7

With Internal Coolant through the Collar

Mit innerer Kühlmittelzufuhr über den Bund

Merkezden ve Flanştan Su Kanallı

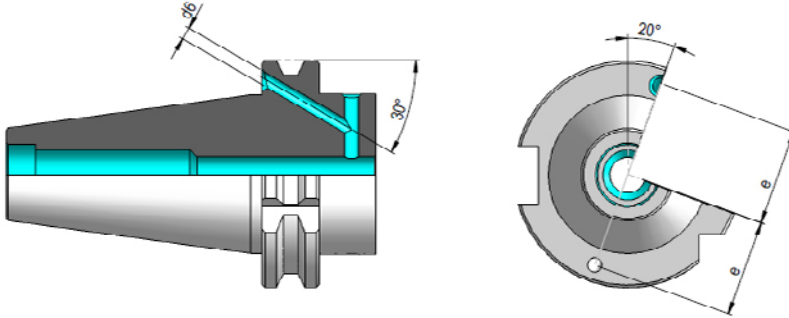

Material	: Case hardened steel, tensile strength in the core min. 950 N/mm ²
Technical Info	: Case hardened HRC 58 ± 2 depth of case 0,6 mm ± 0,2 mm, black - finish
Accuracy	: Cone angle AT3 according to DIN 2080 Surface roughness of cone max 0,001 mm
Werkstoff	: Legierter Einsatzstahl mit einer Zugfestigkeit im Kern von min. 950 N/mm ²
Ausführung	: Einsatzgehärtet HRC 58 ± 2 Härtetiefe 0,6 mm ± 0,2 mm, brüniert
Genauigkeit	: Kegelwinkel - Toleranzqualität AT3 nach DIN 2080 Oberflächenrauigkeit des Kegels max. 0,001 mm
Malzeme	: Alaşımlı semente çeliği çekme mukavemeti min. 950 N/mm ²
Teknik Özelliği	: Sertlik HRC 58 ± 2 sertlik derinliği 0,6 mm ± 0,2 mm, karartılmış
Hassasiyeti	: Konik açı tolerans kalitesi DIN 2080 normuna göre AT3 Konik yüzey kalitesi max. 0,001 mm

OZ Collet Chuck DIN 6391

SK (DIN 69871)

Form
AD/B

G6.3
12.000 RPM



OZ Spannzangenfutter DIN 6391

OZ Pens Başlığı DIN 6391

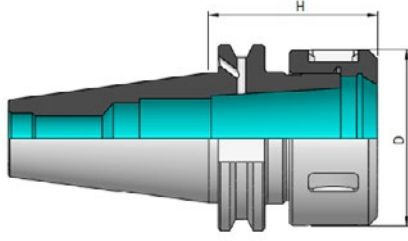

Order No. Bestell-Nr. Sipariş No.	Description Bezeichnung Açıklama	H	Capacity Spannbereich Kapasite	D
140.01.116	SK40 DIN69871 H70 OZ16	70	2-16	43
140.01.125	SK40 DIN69871 H70 OZ25	70	2-25	60
140.01.132	SK40 DIN69871 H80 OZ32	80	4-32	72
140.01.225	SK40 DIN69871 H100 OZ25	100	2-25	60
150.01.116	SK50 DIN69871 H70 OZ16	70	2-16	43
150.01.125	SK50 DIN69871 H70 OZ25	70	2-15	60
150.01.132	SK50 DIN69871 H80 OZ32	80	4-32	72
150.01.232	SK50 DIN69871 H100 OZ32	100	4-32	72



Collet
Spannzange
Pens

129



Clamping Nut
Spannmutter
Kapak

138



Wrench
Hakenschlüssel
Ay Anahtarı

142

ER Collet Chuck DIN 6499

SK (DIN 69871)

Form
AD/BG6.3
12.000 RPM

ER Spannzangenfutter DIN 6499

ER Pens Başığı DIN 6499

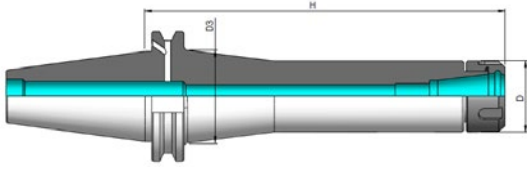

Order No. Bestell-Nr. Sipariş No.	Description Bezeichnung Açıklama	H	Capacity Spannbereich Kapasite	D	D3
140.02.110	SK40 DIN69871 H70 ER16	70	1-10	32	-
140.02.113	SK40 DIN69871 H70 ER20	70	1-13	35	-
140.02.116	SK40 DIN69871 H70 ER25	70	2-16	42	-
140.02.120	SK40 DIN69871 H70 ER32	70	2-20	50	-
140.02.126	SK40 DIN69871 H70 ER40	70	3-26	63	-
140.02.210	SK40 DIN69871 H100 ER16	100	1-10	32	-
140.02.213	SK40 DIN69871 H100 ER20	100	1-13	35	-
140.02.216	SK40 DIN69871 H100 ER25	100	2-16	42	-
140.02.220	SK40 DIN69871 H100 ER32	100	2-20	50	-
140.02.226	SK40 DIN69871 H100 ER40	100	3-26	63	-
140.02.310	SK40 DIN69871 H130 ER16	130	1-10	32	-
140.02.316	SK40 DIN69871 H130 ER25	130	2-16	42	-
140.02.320	SK40 DIN69871 H130 ER32	130	2-20	50	-
140.02.326	SK40 DIN69871 H130 ER40	130	3-26	63	-
140.02.410	SK40 DIN69871 H160 ER16	160	1-10	32	-
140.02.416	SK40 DIN69871 H160 ER25	160	2-16	42	-
140.02.420	SK40 DIN69871 H160 ER32	160	2-20	50	-
140.02.426	SK40 DIN69871 H160 ER40	160	3-26	63	-
140.02.510	SK40 DIN69871 H200 ER16	200	1-10	32	38
140.02.516	SK40 DIN69871 H200 ER25	200	2-16	42	-
140.02.520	SK40 DIN69871 H200 ER32	200	2-20	50	-
140.02.526	SK40 DIN69871 H200 ER40	200	3-26	63	-

Collet
Spannzange
Pens

128

Clamping Nut
Spannmutter
Kapak

138

Wrench
Spannschlüssel
Ay Anahtarı

142

TOOLING TECHNOLOGY

Gisstec®



ER Collet Chuck DIN 6499

SK (DIN 69871)

Form
AD/B

G6.3
12.000 RPM



ER Spannzangenfutter DIN 6499

ER Pens Başlığı DIN 6499

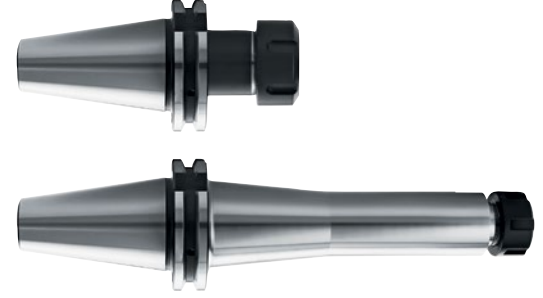
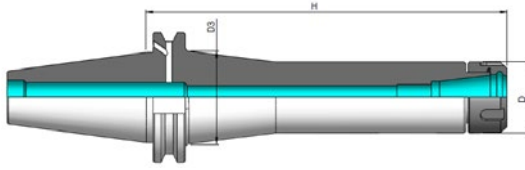

Order No. Bestell-Nr. Sipariş No.	Description Bezeichnung Açıklama	H	Capacity Spannbereich Kapasite	D	D3
150.02.110	SK50 DIN69871 H80 ER16	80	1-10	32	-
150.02.113	SK50 DIN69871 H80 ER20	80	1-13	35	-
150.02.116	SK50 DIN69871 H80 ER25	80	2-16	42	-
150.02.120	SK50 DIN69871 H80 ER32	80	2-20	50	-
150.02.126	SK50 DIN69871 H80 ER40	80	3-26	63	-
150.02.210	SK50 DIN69871 H100 ER16	100	1-10	32	-
150.02.213	SK50 DIN69871 H100 ER20	100	1-13	35	-
150.02.216	SK50 DIN69871 H100 ER25	100	2-16	42	-
150.02.220	SK50 DIN69871 H100 ER32	100	2-20	50	-
150.02.226	SK50 DIN69871 H100 ER40	100	3-26	63	-
150.02.310	SK50 DIN69871 H130 ER16	130	1-10	32	-
150.02.316	SK50 DIN69871 H130 ER25	130	2-16	42	-
150.02.320	SK50 DIN69871 H130 ER32	130	2-20	50	-
150.02.326	SK50 DIN69871 H130 ER40	130	3-26	63	-
150.02.410	SK50 DIN69871 H160 ER16	160	1-10	32	-
150.02.416	SK50 DIN69871 H160 ER25	160	2-16	42	-
150.02.420	SK50 DIN69871 H160 ER32	160	2-20	50	-
150.02.426	SK50 DIN69871 H160 ER40	160	3-26	63	-
150.02.510	SK50 DIN69871 H200 ER16	200	1-10	32	38
150.02.516	SK50 DIN69871 H200 ER25	200	2-16	42	-
150.02.520	SK50 DIN69871 H200 ER32	200	2-20	50	-
150.02.526	SK50 DIN69871 H200 ER40	200	3-26	63	-



Collet
Spannzange
Pens

128



Clamping Nut
Spannmutter
Kapak

138



Wrench
Spannschlüssel
Ay Anahtarı

142

ER Mini Collet Chuck DIN 6499

SK (DIN 69871)

Form
AD/BG6.3
12.000 RPM

Spannzangenfutter ER Mini DIN 6499

ER Mini Pens Başlığı DIN 6499

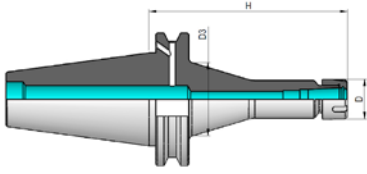

Order No. Bestell-Nr. Sipariş No.	Description Bezeichnung Açıklama	H	Capacity Spannbereich Kapasite	D	D3
140.2M.110	SK40 DIN69871 H70 ER16Mini	70	1-10	22	26
140.2M.207	SK40 DIN69871 H100 ER11Mini	100	1-7	16	21
140.2M.210	SK40 DIN69871 H100 ER16Mini	100	1-10	22	27
140.2M.213	SK40 DIN69871 H100 ER20Mini	100	1-13	28	28
140.2M.307	SK40 DIN69871 H130 ER11Mini	130	1-7	16	22
140.2M.310	SK40 DIN69871 H130 ER16Mini	130	1-10	22	27
140.2M.407	SK40 DIN69871 H160 ER11Mini	160	1-7	16	22
140.2M.410	SK40 DIN69871 H160 ER16Mini	160	1-10	22	27
140.2M.510	SK40 DIN69871 H200 ER16Mini	200	1-10	22	32
150.2M.210	SK50 DIN69871 H100 ER16Mini	100	1-10	22	28
150.2M.410	SK50 DIN69871 H160 ER16Mini	160	1-10	22	30
150.2M.510	SK50 DIN69871 H200 ER16Mini	200	1-10	22	30

TOOLING TECHNOLOGY

Gisstec®

Collet
Spannzange
Pens

128

Clamping Nut Mini
Spannmutter Mini
Kapak Mini

139

Wrench for Mini
Spannschlüssel für Mini
Ay Anahtarları Mini

143



Ultra Precise Collet Chuck

SK (DIN 69871)

Form
AD/B

G2.5
20.000 RPM



Ultra-Präzises Spannzangenfutter

Ultra Hassas Pens Başlığı

Clamping Power / Spannkraft / Sıkma Kuvveti **+ 25%**

Runout / Rundlauf / Salgı **0,003 mm**

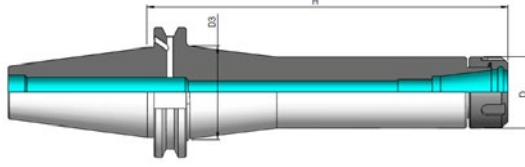

Order No. Bestell-Nr. Sipariş No.	Description Bezeichnung Açıklama	H	Capacity Spannbereich Kapasite	D
140.2U.110	SK40 DIN69871 H70 ER16	70	1-10	30
140.2U.116	SK40 DIN69871 H70 ER25	70	1-16	40
140.2U.120	SK40 DIN69871 H70 ER32	70	1-20	50
140.2U.210	SK40 DIN69871 H100 ER16	100	1-10	30
140.2U.316	SK40 DIN69871 H120 ER25	120	1-16	40
140.2U.320	SK40 DIN69871 H120 ER32	120	1-20	50
140.2U.410	SK40 DIN69871 H150 ER16	150	1-10	30
150.2U.110	SK50 DIN69871 H70 ER16	70	1-10	30
150.2U.120	SK50 DIN69871 H70 ER32	70	1-20	50
150.2U.320	SK50 DIN69871 H130 ER32	130	1-20	50
150.2U.410	SK50 DIN69871 H150 ER16	150	1-10	30



Milling Chuck

SK (DIN 69871)

Form
AD

G6.3
12.000 RPM



Kraftspannfutter

Bilyalı Pens Başlığı

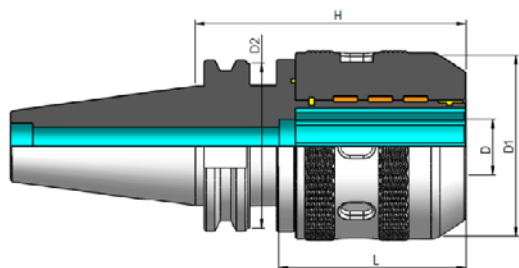

Order No. Bestell-Nr. Sipariş No.	Description Bezeichnung Açıklama	H	D	D1	D2	L
140.03.120	SK40 DIN69871 H75 6-20	75	20	46	47	60
140.03.132	SK40 DIN69871 H105 6-32	105	32	62	63	80
140.03.332	SK40 DIN69871 H135 6-32	135	32	62	63	80
150.03.120	SK50 DIN69871 H85 6-20	85	20	46	47	60
150.03.132	SK50 DIN69871 H85 6-32	85	32	62	63	80
150.03.332	SK50 DIN69871 H135 6-32	135	32	62	63	80

Milling Chuck Kit in Plastic Box

Kraftspannfuttersatz im Koffer

Bilyalı Pens Başlığı Seti, Plastik Kutulu

Form
AD



Order No. Bestell-Nr. Sipariş No.	Description Bezeichnung Açıklama	Collets Spannzangen Pensler
140.03.K20	SK40 DIN69871 H75 6-20	Ø6, Ø8, Ø10, Ø12, Ø16
140.03.K32	SK40 DIN69871 H105 6-32	Ø6, Ø8, Ø10, Ø12, Ø16, Ø20, Ø25
150.03.K32	SK50 DIN69871 H85 6-32	Ø6, Ø8, Ø10, Ø12, Ø16, Ø20, Ø25



Collet
Spannzange
Pens

136



Wrench
Hakenschlüssel
Ay Anahtarı

142

Ultra Clamp

SK (DIN 69871)

Form
AD/B

G2.5
20.000 RPM



Ultra Clamp

Ultra Clamp

Clamping Power / Spannkraft / Sıkma Kuvveti **800 Nm**

Runout / Rundlauf / Salgı **0,003 mm**

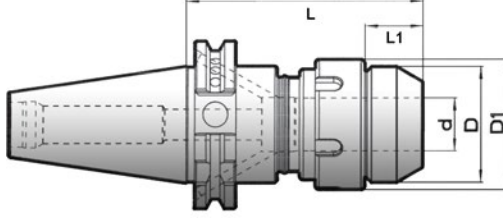

Order No. Bestell-Nr. Sipariş No.	Description Bezeichnung Açıklama	d	L	D1	D	L1	Nm
140.3U.106	SK40 Ø6 x 74	6	74	32	26	11	150
140.3U.108	SK40 Ø8 x 75	8	75	32	27	11	180
140.3U.110	SK40 Ø10 x 79	10	79	37	32	13	320
140.3U.112	SK40 Ø12 x 85	12	85	37	35	20	380
140.3U.116	SK40 Ø16 x 88	16	88	44	40	21	400
140.3U.120	SK40 Ø20 x 90	20	90	49	46	23	520
140.3U.125	SK40 Ø25 x 97	25	97	54	52	26	550
140.3U.132	SK40 Ø32 x 105	32	105	68	67	33	800
140.3U.420	SK40 Ø20 x 150	20	150	49	46	23	520
140.3U.432	SK40 Ø32 x 150	32	150	68	67	33	800
150.3U.106	SK50 Ø6 x 74	6	74	32	26	11	150
150.3U.108	SK50 Ø8 x 75	8	75	32	27	11	180
150.3U.110	SK50 Ø10 x 79	10	79	37	32	13	320
150.3U.112	SK50 Ø12 x 85	12	85	37	35	20	380
150.3U.116	SK50 Ø16 x 88	16	88	44	40	21	400
150.3U.120	SK50 Ø20 x 90	20	90	49	46	23	520
150.3U.125	SK50 Ø25 x 97	25	97	54	52	26	550
150.3U.132	SK50 Ø32 x 105	32	103	68	67	33	800
150.3U.420	SK40 Ø20 x 150	20	150	49	46	23	520
150.3U.432	SK40 Ø32 x 150	32	150	68	67	33	800

Suitable for cylindrical shaft
and weldon tools

Vibration dampening

Axial tool adjustment

Coolant through up to 100 bar

Geeignet für Werkzeuge mit
zylindrischem Schaft und Weldon

Vibrationsdämpfung

Längeneinstellung

IK bis 100 bar

Silindirik ve veldon şaftlı
kesiciler için

Vibrasyon sönümlenme

Kesici boy ayarı

100 bara kadar içten su verme



Collet
Spannzange
Pens

136



Wrench
Hakenschlüssel
Ay Anahtarı

142

End Mill Holder DIN 6359 / 1835 B, short

SK (DIN 69871)

Form
AD/B

G6.3
12.000 RPM



Fräseraufnahme DIN 6359 / 1835 B, kurz

Veldon Tutucu DIN 6359 / 1835 B, kısa

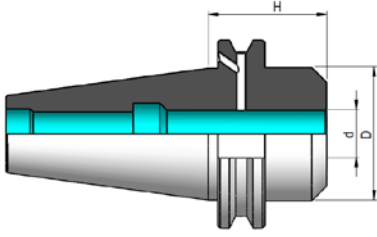

Order No. Bestell-Nr. Sipariş No.	Description Bezeichnung Açıklama	H	d	D
140.04.016	SK40 DIN69871 H35 d16	35	16	44
140.04.020	SK40 DIN69871 H35 d20	35	20	44
140.04.025	SK40 DIN69871 H35 d25	35	25	50
140.04.032	SK40 DIN69871 H70 d32	70	32	72
150.04.016	SK50 DIN69871 H35 d16	35	16	70
150.04.020	SK50 DIN69871 H35 d20	35	20	70
150.04.025	SK50 DIN69871 H35 d25	35	25	70
150.04.032	SK50 DIN69871 H35 d32	35	32	80
150.04.040	SK50 DIN69871 H35 d40	35	40	80



Clamping Screw
Spanschraube
Sıkma Civatası

148

TOOLING TECHNOLOGY

Gisstec®



End Mill Holder DIN 6359 / 1835 B

SK (DIN 69871)

Form
AD/B

G6.3
12.000 RPM



Fräseraufnahme DIN 6359 /1835 B

Veldon Tutucu DIN 6359 / 1835 B

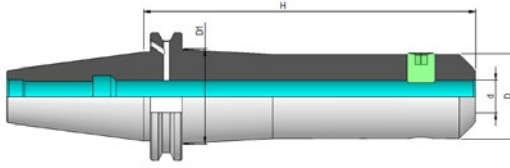

Order No. Bestell-Nr. Sipariş No.	Description Bezeichnung Açıklama	H	d	D	D1
140.04.106	SK40 DIN69871 H50 d 6	50	6	25	-
140.04.108	SK40 DIN69871 H50 d 8	50	8	28	-
140.04.110	SK40 DIN69871 H50 d10	50	10	35	-
140.04.112	SK40 DIN69871 H50 d12	50	12	42	-
140.04.114	SK40 DIN69871 H50 d14	50	14	44	-
140.04.116	SK40 DIN69871 H63 d16	63	16	48	-
140.04.118	SK40 DIN69871 H63 d18	63	18	50	-
140.04.120	SK40 DIN69871 H63 d20	63	20	52	-
140.04.125	SK40 DIN69871 H100 d25	100	25	65	-
140.04.132	SK40 DIN69871 H100 d32	100	32	72	-
140.04.140	SK40 DIN69871 H120 d40	120	40	80	-
140.04.206	SK40 DIN69871 H100 d 6	100	6	25	-
140.04.208	SK40 DIN69871 H100 d 8	100	8	28	-
140.04.210	SK40 DIN69871 H100 d10	100	10	35	-
140.04.212	SK40 DIN69871 H100 d12	100	12	42	-
140.04.214	SK40 DIN69871 H100 d14	100	14	44	-
140.04.216	SK40 DIN69871 H100 d16	100	16	48	-
140.04.218	SK40 DIN69871 H100 d18	100	18	50	-
140.04.220	SK40 DIN69871 H100 d20	100	20	50	-
140.04.306	SK40 DIN69871 H130 d 6	130	6	25	-
140.04.308	SK40 DIN69871 H130 d 8	130	8	28	-
140.04.310	SK40 DIN69871 H130 d10	130	10	35	-
140.04.312	SK40 DIN69871 H130 d12	130	12	42	-
140.04.314	SK40 DIN69871 H130 d14	130	14	44	-
140.04.316	SK40 DIN69871 H130 d16	130	16	48	-
140.04.318	SK40 DIN69871 H130 d18	130	18	50	-
140.04.320	SK40 DIN69871 H130 d20	130	20	50	-
140.04.325	SK40 DIN69871 H130 d25	130	25	65	-



Clamping Screw
Spannschraube
Sikma Civatası

148

End Mill Holder DIN 6359 / 1835 B, extended

SK (DIN 69871)

Form
AD/B

G6.3
12.000 RPM



Fräseraufnahme DIN 6359 / 1835 B, verlängert

Veldon Tutucu DIN 6359 / 1835 B, uzun boy

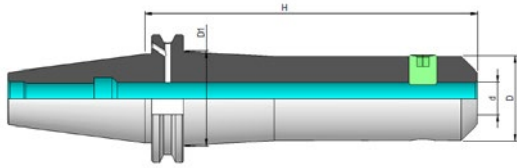

Order No. Bestell-Nr. Sipariş No.	Description Bezeichnung Açıklama	H	d	D	D1
140.04.406	SK40 DIN69871 H160 d 6	160	6	25	-
140.04.408	SK40 DIN69871 H160 d 8	160	8	28	-
140.04.410	SK40 DIN69871 H160 d10	160	10	35	-
140.04.412	SK40 DIN69871 H160 d12	160	12	42	-
140.04.414	SK40 DIN69871 H160 d14	160	14	44	-
140.04.416	SK40 DIN69871 H160 d16	160	16	48	-
140.04.418	SK40 DIN69871 H160 d18	160	18	50	-
140.04.420	SK40 DIN69871 H160 d20	160	20	50	-
140.04.425	SK40 DIN69871 H160 d25	160	25	65	-
140.04.432	SK40 DIN69871 H160 d32	160	32	72	-
140.04.506	SK40 DIN69871 H200 d 6	200	6	25	-
140.04.508	SK40 DIN69871 H200 d 8	200	8	28	-
140.04.510	SK40 DIN69871 H200 d10	200	10	35	-
140.04.512	SK40 DIN69871 H200 d12	200	12	42	-
140.04.514	SK40 DIN69871 H200 d14	200	14	44	-
140.04.516	SK40 DIN69871 H200 d16	200	16	48	-
140.04.518	SK40 DIN69871 H200 d18	200	18	50	-
140.04.520	SK40 DIN69871 H200 d20	200	20	50	-
140.04.525	SK40 DIN69871 H200 d25	200	25	65	-
140.04.532	SK40 DIN69871 H200 d32	200	32	72	-



Clamping Screw
Spannschraube
Sıkma Civatası

148

TOOLING TECHNOLOGY

Gisstec®



End Mill Holder DIN 6359 / 1835 B

SK (DIN 69871)

Form
AD/B

G6.3
12.000 RPM



Fräseraufnahme DIN 6359 /1835 B

Veldon Tutucu DIN 6359 / 1835 B

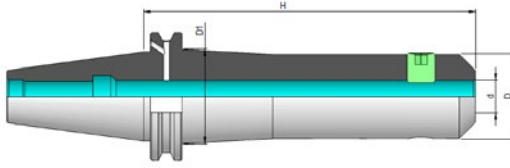

Order No. Bestell-Nr. Sipariş No.	Description Bezeichnung Açıklama	H	d	D	D1
150.04.106	SK50 DIN69871 H63 d 6	63	6	25	-
150.04.108	SK50 DIN69871 H63 d 8	63	8	28	-
150.04.110	SK50 DIN69871 H63 d10	63	10	35	-
150.04.112	SK50 DIN69871 H63 d12	63	12	42	-
150.04.114	SK50 DIN69871 H63 d14	63	14	44	-
150.04.116	SK50 DIN69871 H63 d16	63	16	48	-
150.04.118	SK50 DIN69871 H63 d18	63	18	50	-
150.04.120	SK50 DIN69871 H63 d20	63	20	52	-
150.04.125	SK50 DIN69871 H80 d25	80	25	65	-
150.04.132	SK50 DIN69871 H100 d32	100	32	72	-
150.04.140	SK50 DIN69871 H120 d40	120	40	80	-
150.04.206	SK50 DIN69871 H100 d 6	100	6	25	-
150.04.208	SK50 DIN69871 H100 d 8	100	8	28	-
150.04.210	SK50 DIN69871 H100 d10	100	10	35	-
150.04.212	SK50 DIN69871 H100 d12	100	12	42	-
150.04.214	SK50 DIN69871 H100 d14	100	14	44	-
150.04.216	SK50 DIN69871 H100 d16	100	16	48	-
150.04.218	SK50 DIN69871 H100 d18	100	18	50	-
150.04.220	SK50 DIN69871 H100 d20	100	20	52	-
150.04.225	SK50 DIN69871 H100 d25	100	25	65	-
150.04.306	SK50 DIN69871 H130 d 6	130	6	25	-
150.04.308	SK50 DIN69871 H130 d 8	130	8	28	-
150.04.310	SK50 DIN69871 H130 d10	130	10	35	-
150.04.312	SK50 DIN69871 H130 d12	130	12	42	-
150.04.314	SK50 DIN69871 H130 d14	130	14	44	-
150.04.316	SK50 DIN69871 H130 d16	130	16	48	-
150.04.318	SK50 DIN69871 H130 d18	130	18	50	-
150.04.320	SK50 DIN69871 H130 d20	130	20	52	-
150.04.325	SK50 DIN69871 H130 d25	130	25	65	-
150.04.332	SK50 DIN69871 H130 d32	130	32	72	-



Clamping Screw
Spannschraube
Sikma Civatası

148

End Mill Holder DIN 6359 / 1835 B, extended

SK (DIN 69871)

Form
AD/B

G6.3
12.000 RPM



Fräseraufnahme DIN 6359 / 1835 B, verlängert

Veldon Tutucu DIN 6359 / 1835 B, uzun boy

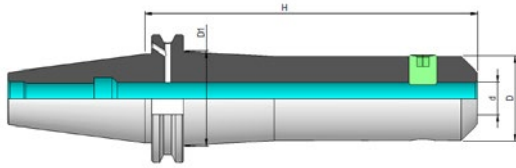

Order No. Bestell-Nr. Sipariş No.	Description Bezeichnung Açıklama	H	d	D	D1
150.04.406	SK50 DIN69871 H160 d 6	160	6	25	-
150.04.408	SK50 DIN69871 H160 d 8	160	8	28	-
150.04.410	SK50 DIN69871 H160 d10	160	10	35	-
150.04.412	SK50 DIN69871 H160 d12	160	12	42	-
150.04.414	SK50 DIN69871 H160 d14	160	14	44	-
150.04.416	SK50 DIN69871 H160 d16	160	16	48	-
150.04.418	SK50 DIN69871 H160 d18	160	18	50	-
150.04.420	SK50 DIN69871 H160 d20	160	20	52	-
150.04.425	SK50 DIN69871 H160 d25	160	25	65	-
150.04.432	SK50 DIN69871 H160 d32	160	32	65	-
150.04.440	SK50 DIN69871 H160 d40	160	40	80	-
150.04.506	SK50 DIN69871 H200 d 6	200	6	25	-
150.04.508	SK50 DIN69871 H200 d 8	200	8	28	-
150.04.510	SK50 DIN69871 H200 d10	200	10	35	-
150.04.512	SK50 DIN69871 H200 d12	200	12	42	-
150.04.514	SK50 DIN69871 H200 d14	200	14	44	-
150.04.516	SK50 DIN69871 H200 d16	200	16	48	-
150.04.518	SK50 DIN69871 H200 d18	200	18	50	-
150.04.520	SK50 DIN69871 H200 d20	200	20	52	-
150.04.525	SK50 DIN69871 H200 d25	200	25	65	-
150.04.532	SK50 DIN69871 H200 d32	200	32	72	-
150.04.540	SK50 DIN69871 H200 d40	200	40	80	-



Clamping Screw
Spannschraube
Sıkma Civatası

148

TOOLING TECHNOLOGY

Gisstec®



End Mill Holder with Coolant Channel DIN 6359 / 1835 B

SK (DIN 69871)

Form
AD/B

G6.3
12.000 RPM



Fräseraufnahme mit Kühlkanal DIN 6359 / 1835 B

Veldon Tutucu İçten Soğutmalı DIN 6359 / 1835 B

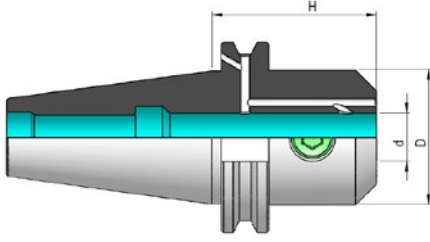

Order No. Bestell-Nr. Sipariş No.	Description Bezeichnung Açıklama	H	d	D
140.4K.106	SK40 DIN69871 H 50 d 6	50	6	25
140.4K.108	SK40 DIN69871 H 50 d 8	50	8	28
140.4K.110	SK40 DIN69871 H 50 d10	50	10	35
140.4K.112	SK40 DIN69871 H 50 d12	50	12	42
140.4K.114	SK40 DIN69871 H 50 d14	50	14	44
140.4K.116	SK40 DIN69871 H 63 d16	63	16	48
140.4K.118	SK40 DIN69871 H 63 d18	63	18	50
140.4K.120	SK40 DIN69871 H 63 d20	63	20	52
140.4K.125	SK40 DIN69871 H100 d25	100	25	63
140.4K.132	SK40 DIN69871 H100 d32	100	32	72
150.4K.106	SK50 DIN69871 H 63 d 6	63	6	25
150.4K.108	SK50 DIN69871 H 63 d 8	63	8	28
150.4K.110	SK50 DIN69871 H 63 d10	63	10	35
150.4K.112	SK50 DIN69871 H 63 d12	63	12	42
150.4K.114	SK50 DIN69871 H 63 d14	63	14	44
150.4K.116	SK50 DIN69871 H 63 d16	63	16	48
150.4K.118	SK50 DIN69871 H 63 d18	63	18	50
150.4K.120	SK50 DIN69871 H 63 d20	63	20	52
150.4K.125	SK50 DIN69871 H 80 d25	80	25	65
150.4K.132	SK50 DIN69871 H100 d32	100	32	72
150.4K.140	SK50 DIN69871 H120 d40	120	40	80



Clamping Screw
Spannschraube
Sikma Civatası

148

End Mill Holder Whistle Notch DIN 6359 / 1835 E

SK (DIN 69871)

Form
AD/BG6.3
12.000 RPM

Fräseraufnahme Whistle Notch DIN 6359 / 1835 E

Veldon Tutucu, 2° Açılı DIN 6359 / 1835 E

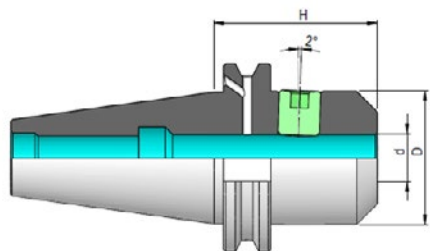

Order No. Bestell-Nr. Sipariş No.	Description Bezeichnung Açıklama	H	d	D
140.05.106	SK40 DIN69871 H 50 d 6	50	6	25
140.05.108	SK40 DIN69871 H 50 d 8	50	8	28
140.05.110	SK40 DIN69871 H 50 d10	50	10	35
140.05.112	SK40 DIN69871 H 50 d12	50	12	42
140.05.114	SK40 DIN69871 H 50 d14	50	14	44
140.05.116	SK40 DIN69871 H 63 d16	63	16	48
140.05.118	SK40 DIN69871 H 63 d18	63	18	50
140.05.120	SK40 DIN69871 H 63 d20	63	20	52
140.05.125	SK40 DIN69871 H100 d25	100	25	65
140.05.132	SK40 DIN69871 H100 d32	100	32	72
140.05.140	SK40 DIN69871 H115 d40	115	40	80
150.05.106	SK50 DIN69871 H 63 d 6	63	6	25
150.05.108	SK50 DIN69871 H 63 d 8	63	8	28
150.05.110	SK50 DIN69871 H 63 d10	63	10	35
150.05.112	SK50 DIN69871 H 63 d12	63	12	42
150.05.114	SK50 DIN69871 H 63 d14	63	14	44
150.05.116	SK50 DIN69871 H 63 d16	63	16	48
150.05.118	SK50 DIN69871 H 63 d18	63	18	50
150.05.120	SK50 DIN69871 H 63 d20	63	20	52
150.05.125	SK50 DIN69871 H 80 d25	80	25	65
150.05.132	SK50 DIN69871 H100 d32	100	32	72
150.05.140	SK50 DIN69871 H120 d40	120	40	80

Clamping Screw
Spannschraube
Sıkma Civatası

148

TOOLING TECHNOLOGY

Gisstec®



Morse Taper Adaptor DIN 6383

SK (DIN 69871)

Form
AD/B

G6.3
12.000 RPM



Zwischenhülse mit Austreibblappen DIN 6383

Mors Adaptörü DIN 6383

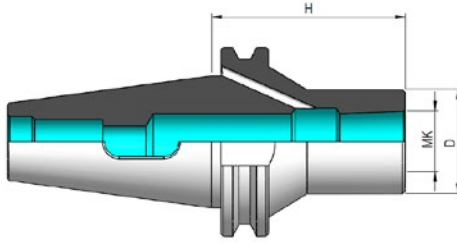

Order No. Bestell-Nr. Sipariş No.	Description Bezeichnung Açıklama	H	D	MK
140.07.101	SK40 DIN69871 H 50 MK1	50	25	1
140.07.102	SK40 DIN69871 H 50 MK2	50	32	2
140.07.103	SK40 DIN69871 H 70 MK3	70	40	3
140.07.104	SK40 DIN69871 H 95 MK4	95	48	4
150.07.101	SK50 DIN69871 H 45 MK1	45	25	1
150.07.102	SK50 DIN69871 H 60 MK2	60	32	2
150.07.103	SK50 DIN69871 H 65 MK3	65	40	3
150.07.104	SK50 DIN69871 H 95 MK4	95	48	4
150.07.105	SK50 DIN69871 H105 MK5	105	63	5

Morse Taper Adaptor with Thread DIN 6364

SK (DIN 69871)

Form
AG6.3
12.000 RPM

Zwischenhülse mit Anzugsgewinde DIN 6364

Çektirmeli Mors Adaptörü DIN 6364

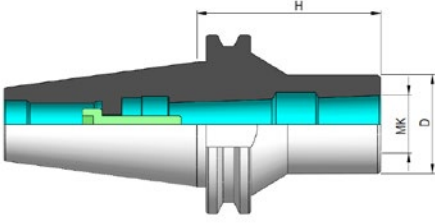

Order No. Bestell-Nr. Sipariş No.	Description Bezeichnung Açıklama	H	D	MK
140.08.101	SK40 DIN69871 H 50 CMK1	50	25	1
140.08.102	SK40 DIN69871 H 50 CMK2	50	32	2
140.08.103	SK40 DIN69871 H 70 CMK3	70	40	3
140.08.104	SK40 DIN69871 H 95 CMK4	95	48	4
150.08.101	SK50 DIN69871 H 50 CMK1	50	25	1
150.08.102	SK50 DIN69871 H 50 CMK2	50	32	2
150.08.103	SK50 DIN69871 H 65 CMK3	65	40	3
150.08.104	SK50 DIN69871 H 95 CMK4	95	48	4
150.08.105	SK50 DIN69871 H100 CMK5	100	63	5

Reduction SleeveForm
A

Reduzierhülse

Redüksiyon Çektirmeli

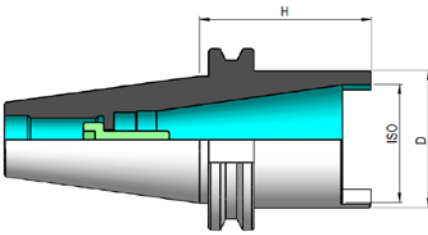

Order No. Bestell-Nr. Sipariş No.	Description Bezeichnung Açıklama	H	D	ISO
140.09.130	SK40 DIN69871 H 70 ISO30	70	49	30
140.09.140	SK40 DIN69871 H100 ISO40	100	68	40
150.09.140	SK50 DIN69871 H 70 ISO40	70	68	40
150.09.150	SK50 DIN69871 H120 ISO50	120	100	50



Combi Shell Mill Holder DIN 6358

SK (DIN 69871)

Form
AD

G6.3
12.000 RPM



Kombi-Aufsteckfräserdorn DIN 6358

Kombine Malafa DIN 6358

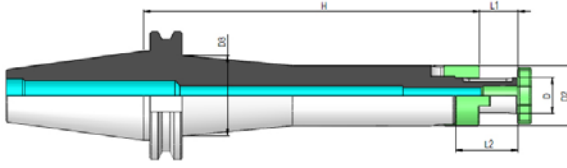

Order No. Bestell-Nr. Sipariş No.	Description Bezeichnung Açıklama	H	L1	L2	D	D2	D3
140.10.116	SK40 DIN69871 H55 D16	55	17	27	16	32	-
140.10.122	SK40 DIN69871 H55 D22	55	19	31	22	40	-
140.10.127	SK40 DIN69871 H55 D27	55	21	33	27	48	-
140.10.132	SK40 DIN69871 H60 D32	60	24	38	32	58	-
140.10.140	SK40 DIN69871 H60 D40	60	27	41	40	70	-
140.10.216	SK40 DIN69871 H100 D16	100	17	27	16	32	-
140.10.222	SK40 DIN69871 H100 D22	100	19	31	22	40	-
140.10.227	SK40 DIN69871 H100 D27	100	21	33	27	48	-
140.10.232	SK40 DIN69871 H100 D32	100	24	38	32	58	-
140.10.240	SK40 DIN69871 H100 D40	100	27	41	40	70	-
140.10.316	SK40 DIN69871 H130 D16	130	17	27	16	32	-
140.10.322	SK40 DIN69871 H130 D22	130	19	31	22	40	-
140.10.327	SK40 DIN69871 H130 D27	130	21	33	27	48	-
140.10.332	SK40 DIN69871 H130 D32	130	24	38	32	58	-
140.10.340	SK40 DIN69871 H130 D40	130	27	41	40	70	-
140.10.416	SK40 DIN69871 H160 D16	160	17	27	16	32	40
140.10.422	SK40 DIN69871 H160 D22	160	19	31	22	40	-
140.10.427	SK40 DIN69871 H160 D27	160	21	33	27	48	-
140.10.432	SK40 DIN69871 H160 D32	160	24	38	32	58	-
140.10.440	SK40 DIN69871 H160 D40	160	27	41	40	70	-
140.10.516	SK40 DIN69871 H200 D16	200	17	27	16	32	40
140.10.522	SK40 DIN69871 H200 D22	200	19	31	22	40	50
140.10.527	SK40 DIN69871 H200 D27	200	21	33	27	48	-
140.10.532	SK40 DIN69871 H200 D32	200	24	38	32	58	-
140.10.540	SK40 DIN69871 H200 D40	200	27	41	40	70	-



Clutch Drive Ring
Mitnehmerring
Tırnaklı Pul

152



Draw-in Bolt
Fräseranzugsschraube
Kelebek Civata

152



Wrench
Spannschlüssel
Anahtar

152



Combi Shell Mill Holder DIN 6358

SK (DIN 69871)

Form
AD

G6.3
12.000 RPM



Kombi-Aufsteckfräserdorn DIN 6358

Kombine Malafa DIN 6358

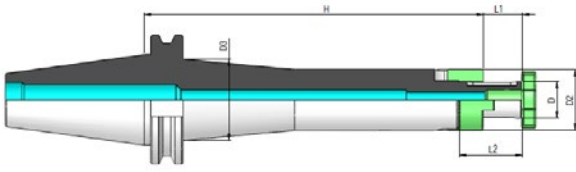

Order No. Bestell-Nr. Sipariş No.	Description Bezeichnung Açıklama	H	L1	L2	D	D2	D3
150.10.116	SK50 DIN69871 H55 D16	55	17	27	16	32	-
150.10.122	SK50 DIN69871 H55 D22	55	19	31	22	40	-
150.10.127	SK50 DIN69871 H55 D27	55	21	33	27	48	-
150.10.132	SK50 DIN69871 H55 D32	55	24	38	32	58	-
150.10.140	SK50 DIN69871 H55 D40	55	27	41	40	70	-
150.10.216	SK50 DIN69871 H100 D16	100	17	27	16	32	-
150.10.222	SK50 DIN69871 H100 D22	100	19	31	22	40	-
150.10.227	SK50 DIN69871 H100 D27	100	21	33	27	48	-
150.10.232	SK50 DIN69871 H100 D32	100	24	38	32	58	-
150.10.240	SK50 DIN69871 H100 D40	100	27	41	40	70	-
150.10.316	SK50 DIN69871 H130 D16	130	17	27	16	32	-
150.10.322	SK50 DIN69871 H130 D22	130	19	31	22	40	-
150.10.327	SK50 DIN69871 H130 D27	130	21	33	27	48	-
150.10.332	SK50 DIN69871 H130 D32	130	24	38	32	58	-
150.10.340	SK50 DIN69871 H130 D40	130	27	41	40	70	-
150.10.416	SK50 DIN69871 H160 D16	160	17	27	16	32	40
150.10.422	SK50 DIN69871 H160 D22	160	19	31	22	40	-
150.10.427	SK50 DIN69871 H160 D27	160	21	33	27	48	-
150.10.432	SK50 DIN69871 H160 D32	160	24	38	32	58	-
150.10.440	SK50 DIN69871 H160 D40	160	27	41	40	70	-
150.10.516	SK50 DIN69871 H200 D16	200	17	27	16	32	40
150.10.522	SK50 DIN69871 H200 D22	200	19	31	22	40	50
150.10.527	SK50 DIN69871 H200 D27	200	21	33	27	48	-
150.10.532	SK50 DIN69871 H200 D32	200	24	38	32	58	-
150.10.540	SK50 DIN69871 H200 D40	200	27	41	40	70	-



Clutch Drive Ring
Mitnehmering
Tırnaklı Pul

152



Draw-in Bolt
Fräseranzugsschraube
Kelebek Civata

152



Wrench
Spannschlüssel
Anahtar

152



Shell Mill Holder DIN 6357

SK (DIN 69871)

Form
AD/B

G6.3
12.000 RPM



Messerkopfaufnahme DIN 6357

Alın Kamalı Malafa DIN 6357

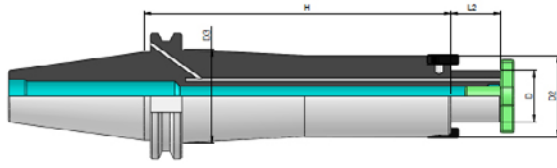

Order No. Bestell-Nr. Sipariş No.	Description Bezeichnung Açıklama	H	L2	D	D2	D3
140.11.116	SK40 DIN69871 H 45 D16	45	17	16	38	-
140.11.122	SK40 DIN69871 H 45 D22	45	19	22	48	-
140.11.127	SK40 DIN69871 H 50 D27	50	21	27	58	-
140.11.132	SK40 DIN69871 H 55 D32	55	24	32	78	-
140.11.140	SK40 DIN69871 H 55 D40	55	27	40	88	-
140.11.216	SK40 DIN69871 H100 D16	100	17	16	38	-
140.11.222	SK40 DIN69871 H100 D22	100	19	22	48	-
140.11.227	SK40 DIN69871 H100 D27	100	21	27	58	-
140.11.232	SK40 DIN69871 H100 D32	100	24	32	78	-
140.11.240	SK40 DIN69871 H100 D40	100	27	40	88	-
140.11.316	SK40 DIN69871 H130 D16	130	17	16	38	-
140.11.322	SK40 DIN69871 H130 D22	130	19	22	48	-
140.11.327	SK40 DIN69871 H130 D27	130	21	27	58	-
140.11.332	SK40 DIN69871 H130 D32	130	24	32	78	-
140.11.340	SK40 DIN69871 H130 D40	130	27	40	88	-
140.11.416	SK40 DIN69871 H160 D16	160	17	16	38	45
140.11.422	SK40 DIN69871 H160 D22	160	19	22	48	-
140.11.427	SK40 DIN69871 H160 D27	160	21	27	58	-
140.11.432	SK40 DIN69871 H160 D32	160	24	32	78	-
140.11.440	SK40 DIN69871 H160 D40	160	27	40	88	-
140.11.516	SK40 DIN69871 H200 D16	200	17	16	38	45
140.11.522	SK40 DIN69871 H200 D22	200	19	22	48	-
140.11.527	SK40 DIN69871 H200 D27	200	21	27	58	-
140.11.532	SK40 DIN69871 H200 D32	200	24	32	78	-
140.11.540	SK40 DIN69871 H200 D40	200	27	40	88	-



Draw-in Bolt
Fräseranzugsschraube
Kelebek Civata

152



Wrench
Spannschlüssel
Anahtar

152

Shell Mill Holder DIN 6357

SK (DIN 69871)

Form
AD/BG6.3
12.000 RPM

Messerkopfaufnahme DIN 6357

Alın Kamalı Malafa DIN 6357

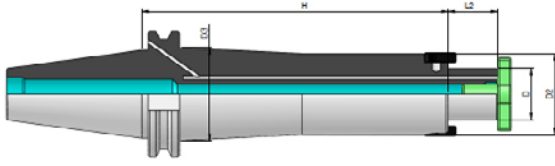

Order No. Bestell-Nr. Sipariş No.	Description Bezeichnung Açıklama	H	L2	D	D2	D3
150.11.116	SK50 DIN69871 H 45 D16	45	17	16	38	-
150.11.122	SK50 DIN69871 H 45 D22	45	19	22	48	-
150.11.127	SK50 DIN69871 H 45 D27	45	21	27	58	-
150.11.132	SK50 DIN69871 H 55 D32	55	24	32	78	-
150.11.140	SK50 DIN69871 H 55 D40	55	27	40	88	-
150.11.216	SK50 DIN69871 H100 D16	100	17	16	38	-
150.11.222	SK50 DIN69871 H100 D22	100	19	22	48	-
150.11.227	SK50 DIN69871 H100 D27	100	21	27	58	-
150.11.232	SK50 DIN69871 H100 D32	100	24	32	78	-
150.11.240	SK50 DIN69871 H100 D40	100	27	40	88	-
150.11.316	SK50 DIN69871 H130 D16	130	17	16	38	-
150.11.322	SK50 DIN69871 H130 D22	130	19	22	48	-
150.11.327	SK50 DIN69871 H130 D27	130	21	27	58	-
150.11.332	SK50 DIN69871 H130 D32	130	24	32	78	-
150.11.340	SK50 DIN69871 H130 D40	130	27	40	88	-
150.11.416	SK50 DIN69871 H160 D16	160	17	16	38	45
150.11.422	SK50 DIN69871 H160 D22	160	19	22	48	-
150.11.427	SK50 DIN69871 H160 D27	160	21	27	58	-
150.11.432	SK50 DIN69871 H160 D32	160	24	32	78	-
150.11.440	SK50 DIN69871 H160 D40	160	27	40	88	-

Draw-in Bolt
Fräseranzugsschraube
Kelebek Civata

152

Wrench
Spannschlüssel
Anahtar

152



Shell Mill Holder DIN 6357, extended

SK (DIN 69871)

Form
AD

G6.3
12.000 RPM



Messerkopfaufnahme DIN 6357, verlängert

Alın Kamalı Malafa DIN 6357, uzun boy

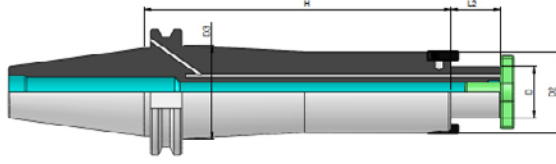

Order No. Bestell-Nr. Sipariş No.	Description Bezeichnung Açıklama	H	L2	D	D2	D3
150.11.516	SK50 DIN69871 H200 D16	200	17	16	38	46
150.11.522	SK50 DIN69871 H200 D22	200	19	22	48	60
150.11.527	SK50 DIN69871 H200 D27	200	21	27	58	78
150.11.532	SK50 DIN69871 H200 D32	200	24	32	78	78
150.11.540	SK50 DIN69871 H200 D40	200	27	40	88	88
150.11.616	SK50 DIN69871 H250 D16	250	17	16	38	52
150.11.622	SK50 DIN69871 H250 D22	250	19	22	48	62
150.11.627	SK50 DIN69871 H250 D27	250	21	27	58	72
150.11.632	SK50 DIN69871 H250 D32	250	24	32	78	78
150.11.640	SK50 DIN69871 H250 D40	250	27	40	88	88
150.11.716	SK50 DIN69871 H300 D16	300	17	16	38	54
150.11.722	SK50 DIN69871 H300 D22	300	19	22	48	65
150.11.727	SK50 DIN69871 H300 D27	300	21	27	58	76
150.11.732	SK50 DIN69871 H300 D32	300	24	32	78	78
150.11.740	SK50 DIN69871 H300 D40	300	27	40	88	88
150.11.816	SK50 DIN69871 H350 D16	350	17	16	38	56
150.11.822	SK50 DIN69871 H350 D22	350	19	22	48	66
150.11.827	SK50 DIN69871 H350 D27	350	21	27	58	76
150.11.832	SK50 DIN69871 H350 D32	350	24	32	78	78



Draw-in Bolt
Fräseranzugsschraube
Kelebek Civata

152



Wrench
Spannschlüssel
Anahtar

152

Face Mill Holder DIN 6357

SK (DIN 69871)

Form
AD/B

G6.3
12.000 RPM



Messerkopfaufnahme DIN 6357

Alın Kamalı Malafa DIN 6357

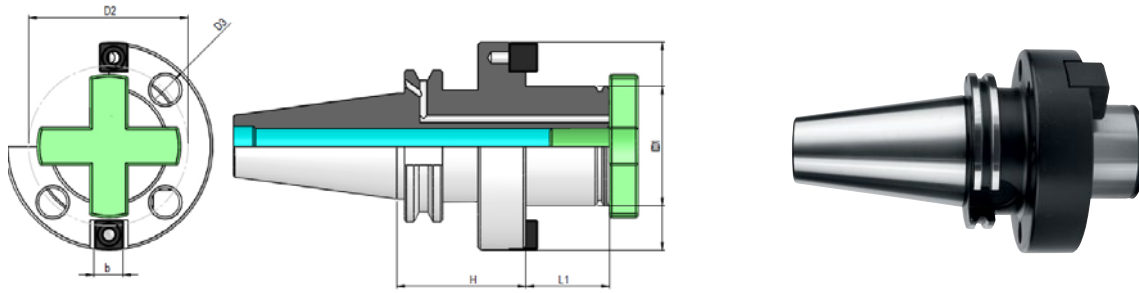

Order No. Bestell-Nr. Sipariş No.	Description Bezeichnung Açıklama	H	D	D1	D2	D3	L1	b
140.13.140	SK40 DIN69871 H60 D40	60	40	89	66,7	M12	30	15,9
150.13.140	SK50 DIN69871 H70 D40	70	40	89	66,7	M12	30	15,9
150.13.160	SK50 DIN69871 H70 D60	70	60	129	101,6	M16	40	25,4

Milling Cutter Arbor

SK (DIN 69871)

Form
AD/B

G2.5
20.000 RPM



Fräserdorn für Aufschraubfräser

Vidalı Freze Takımı

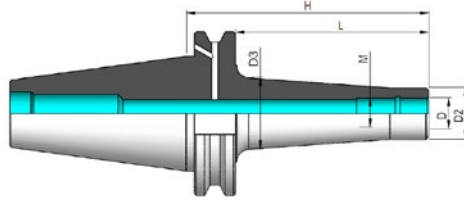

Order No. Bestell-Nr. Sipariş No.	Description Bezeichnung Açıklama	D	D2	D3	H	L	M
140.12.108	SK40 DIN69871 M 8X55	8,5	13	15	55	36	M 8X1,25
140.12.110	SK40 DIN69871 M10x55	10,5	18	19,5	55	36	M10X1,5
140.12.112	SK40 DIN69871 M12x55	12,5	21	24	55	36	M12X1,75
140.12.116	SK40 DIN69871 M16X55	17	29	34	55	36	M16X2
140.12.208	SK40 DIN69871 M 8x75	8,5	13	23	75	56	M 8X1,25
140.12.210	SK40 DIN69871 M10x75	10,5	18	25	75	56	M10X1,5
140.12.212	SK40 DIN69871 M12x75	12,5	21	24	75	56	M12X1,75
140.12.216	SK40 DIN69871 M16x75	17	29	34	75	56	M16X2
140.12.308	SK40 DIN69871 M 8x95	8,5	13	23	95	76	M 8X1,25
140.12.310	SK40 DIN69871 M10x95	10,5	18	28	95	76	M10X1,5
140.12.312	SK40 DIN69871 M12x95	12,5	21	31	95	76	M12X1,75
140.12.316	SK40 DIN69871 M16x95	17	29	34	95	76	M16X2
140.12.410	SK40 DIN69871 M10x115	10,5	18	28	115	96	M10X1,5
140.12.412	SK40 DIN69871 M12x115	12,5	21	31	115	96	M12X1,75
140.12.416	SK40 DIN69871 M16x115	17	29	39	115	96	M16X2
140.12.510	SK40 DIN69871 M10x145	10,5	18	34	145	126	M10X1,5
140.12.512	SK40 DIN69871 M12x145	12,5	21	38	145	126	M12X1,75
140.12.516	SK40 DIN69871 M16x145	17	29	39	145	126	M16X2



Fräserdorn für Aufschraubfräser

Vidalı Freze Takımı

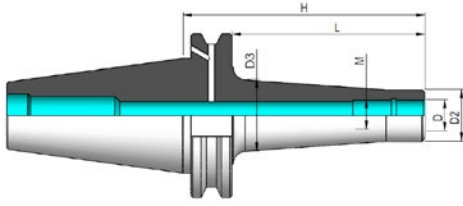

Order No. Bestell-Nr. Sipariş No.	Description Bezeichnung Açıklama	D	D2	D3	H	L	M
150.12.110	SK50 DIN69871 M10X65	10,5	18	19,5	65	46	M10X1,5
150.12.112	SK50 DIN69871 M12X65	12,5	21	24	65	46	M12X1,75
150.12.116	SK50 DIN69871 M16X65	17	29	34	65	46	M16X2
150.12.210	SK50 DIN69871 M10x85	10,5	18	28	85	66	M10X1,5
150.12.212	SK50 DIN69871 M12x85	12,5	21	32	85	66	M12X1,75
150.12.216	SK50 DIN69871 M16x85	17	29	36	85	66	M16X2
150.12.310	SK50 DIN69871 M10x135	10,5	18	28	135	116	M10X1,5
150.12.312	SK50 DIN69871 M12x135	12,5	21	32	135	116	M12X1,75
150.12.316	SK50 DIN69871 M16x135	17	29	36	135	116	M16X2
150.12.410	SK50 DIN69871 M10x185	10,5	18	32	185	166	M10X1,5
150.12.412	SK50 DIN69871 M12x185	12,5	21	36	185	166	M12X1,75
150.12.416	SK50 DIN69871 M16x185	17	29	42	185	166	M16X2
150.12.512	SK50 DIN69871 M12x235	12,5	21	42	235	216	M12X1,75
150.12.516	SK50 DIN69871 M16x235	17	29	44	235	216	M16X2

Drill Chuck Adaptor DIN 238

SK (DIN 69871)

Form
A

G6.3
12.000 RPM



Bohrfutteraufnahme DIN 238

Mandren Malafası DIN 238

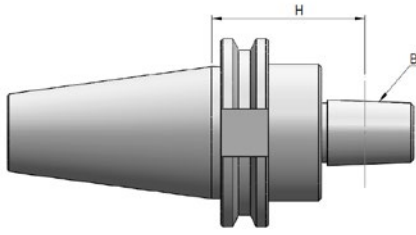

Order No. Bestell-Nr. Sipariş No.	Description Bezeichnung Açıklama	H	B
140.14.112	SK40 DIN69871 H40 B12	40	12
140.14.116	SK40 DIN69871 H40 B16	40	16
140.14.118	SK40 DIN69871 H40 B18	40	18
150.14.112	SK50 DIN69871 H40 B12	40	12
150.14.116	SK50 DIN69871 H40 B16	40	16
150.14.118	SK50 DIN69871 H40 B18	40	18



Drill Chuck
Bohrfutter
Mandren

148



Kurzbohrfutter für Links- und Rechtslauf

NC-Mandren Malafası, Sağ-Sol Dönüşlü

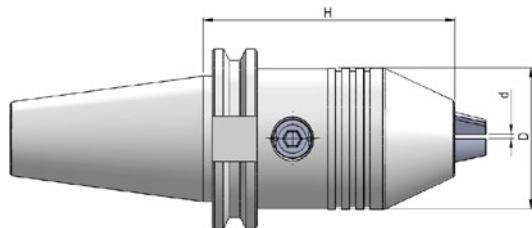

Order No. Bestell-Nr. Sipariş No.	Description Bezeichnung Açıklama	H	D	d
140.15.213	SK40 DIN69871 H87,5 d13	87,5	50	1-13
140.15.216	SK40 DIN69871 H93 d16	93	50	2,5-16
150.15.213	SK50 DIN69871 H87,5 d13	87,5	50	1-13
150.15.216	SK50 DIN69871 H93 d16	93	50	2,5-16
✱ 140.15.108	SK40 DIN69871 H78 d13	78	36	1-13
✱ 140.15.113	SK40 DIN69871 H87,5 d13	87,5	50	1-13
✱ 140.15.116	SK40 DIN69871 H93 d16	93	50	3-16
✱ 150.15.113	SK50 DIN69871 H87,5 d13	87,5	50	1-13
✱ 150.15.116	SK50 DIN69871 H93 d16	93	50	3-16

✱ Form AD



Quick Change Tapping Chuck with Compensation

SK (DIN 69871)

Form
A

Gewindeschneidfutter mit Längenausgleich
Kılavuz Çekme Başlığı, Kompanzeli

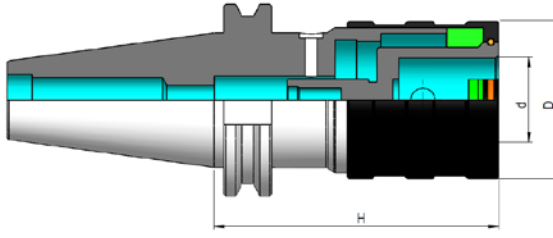

Order No. Bestell-Nr. Sipariş No.	Description Bezeichnung Açıklama	H	d	D	Capacity Spannbereich Kapasite	Compan. - Ext. Druck - zug Giriş - Çıkış
140.16.112	SK40 DIN69871 H60 GR1	60	19	38	M3-M14	9-9
140.16.120	SK40 DIN69871 H100 GR2	100	31	55	M5-M24	15-15
140.16.136	SK40 DIN69871 H138 GR3	138	48	79	M14-M36	24-24
150.16.112	SK50 DIN69871 H62 GR1	62	19	38	M3-M14	9-9
150.16.120	SK50 DIN69871 H83 GR2	83	31	55	M5-M24	15-15
150.16.136	SK50 DIN69871 H133 GR3	133	48	79	M14-M36	24-24

Synchro Quick Change Tapping Chuck

Form
AD

Synchro-Gewindeschneidfutter
Senkronize Kılavuz Çekme Başlığı

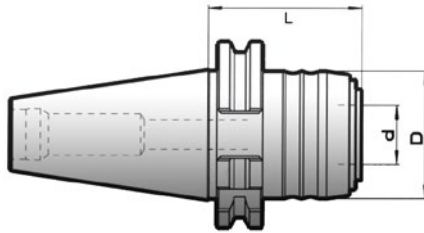

Order No. Bestell-Nr. Sipariş No.	Description Bezeichnung Açıklama	H	d	D	Capacity Spannbereich Kapasite	Compan. - Ext. Druck - zug Giriş - Çıkış
140.26.112	SK40 DIN69871 H53 ER16	53	20	43	M3-M12	0,2 - 1
140.26.120	SK40 DIN69871 H90 ER25	90	32	60	M6-M20	0,2 - 1
150.26.112	SK50 DIN69871 H53 ER16	53	20	43	M3-M12	0,2 - 1
150.26.120	SK50 DIN69871 H74 ER25	74	32	60	M6-M20	0,2 - 1
150.26.133	SK50 DIN69871 H115 ER40 AD/B	115	20	43	M14-M33	0,2 - 1



Tapping Collet
Einsatz
Kılavuz Tutucu

144



Tap Adaptor for Synchro
Einsatz für Synchro
Senkronize için Kılavuz Tutucu

146

Blank Toolholder

SK (DIN 69871)

Form
A**Bohrstangenrohling**
Rohling, Özel Takım Amaçlı

Order No. Bestell-Nr. Sipariş No.	Description Bezeichnung Açıklama	H	D
140.17.263	SK40 DIN69871 Ø63 x 250	250	63
150.17.397	SK50 DIN69871 Ø97 x 315	315	97

Test ArborForm
A**Kontrolldorn**
Kontrol Mastarı

Order No. Bestell-Nr. Sipariş No.	Description Bezeichnung Açıklama	d1	l1	l2	
140.18.300	SK40 DIN69871 Ø40 x 300	40	300	269	0,003
150.18.300	SK50 DIN69871 Ø50 x 300	50	300	267	0,003

Application : For acceptance tests for machine tools according to ISO Recommendation R-230
Verwendung : Zur Abnahme von Werkzeugmaschinen gemäß ISO-Empfehlungen R-230
Açıklama : Tezgah fener milinin ISO normu R-230'a göre uygunluğunu kontrol etmek için

Coolant Feeder

SK (DIN 69871)

Form
A

max.
2.500
RPM



Kühlmittelzuführung

Dıştan Soğutmalı Takım Tutucu

P max.= 20 bar

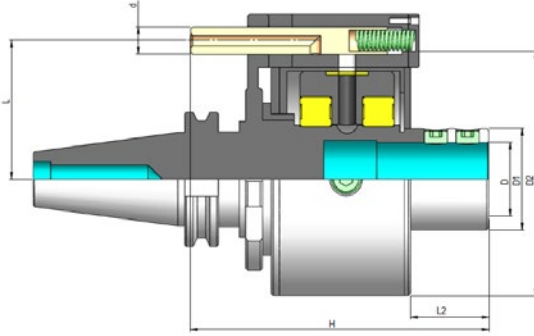

Order No. Bestell-Nr. Sipariş No.	Description Bezeichnung Açıklama	H	L	L2	D	D1	D2	d
140.22.132	SK40 DIN69871 D32	150	65	33,8	32	48	95	18
150.22.140	SK50 DIN69871 D40	160	80	49	40	58	110	18



Reduction Sleeve
Reduzierbuchse
Redüksiyon

137

Shrink Chuck

SK (DIN 69871)

Form
AD/BG2.5
25.000 RPM

Schrumpfutter

Isıtmalı Takım Tutucu

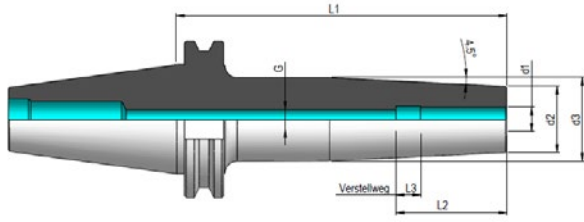

Order No. Bestell-Nr. Sipariş No.	SK	d1	l1	d2	d3	l2	l3	g
140.25.103	SK40	3	80	11	15	10	-	-
140.25.104	SK40	4	80	14	22	20	5	M3
140.25.105	SK40	5	80	16	22	20	-	M4
140.25.106	SK40	6	80	21	27	36	10	M5
140.25.108	SK40	8	80	21	27	36	-	M6
140.25.110	SK40	10	80	24	32	41	-	M8x1
140.25.112	SK40	12	80	24	32	47	-	M10x1
140.25.114	SK40	14	80	27	34	47	-	M10x1
140.25.116	SK40	16	80	27	34	50	-	M12x1
140.25.118	SK40	18	80	33	42	50	-	M12x1
140.25.120	SK40	20	80	33	42	52	-	M16x1
140.25.125	SK40	25	100	44	53	58	-	M16x1
140.25.132	SK40	32	100	44	53	62	-	M16x1
140.25.306	SK40	6	120	21	27	36	10	M5
140.25.308	SK40	8	120	21	27	36	-	M6
140.25.310	SK40	10	120	24	32	41	-	M8x1
140.25.312	SK40	12	120	24	32	47	-	M10x1
140.25.314	SK40	14	120	27	34	47	-	M10x1
140.25.316	SK40	16	120	27	34	50	-	M12x1
140.25.318	SK40	18	120	33	42	50	-	M12x1
140.25.320	SK40	20	120	33	42	52	-	M16x1
140.25.325	SK40	25	120	44	53	58	-	M16x1
140.25.332	SK40	32	120	44	53	62	-	M16x1

Application : For mounting of solid carbide and HSS cutters Ø6 - Ø32 with h6 tolerance and Ø3-4-5 with h4 tolerance

Verwendung : Zum Spannen von HM- und HSS Werkzeugschaften Ø6 - Ø32 mit h6-Toleranz und bei Ø3-4-5 mit h4-Toleranz

Açıklama : Şaftı karbür ve HSS takımlar için şaft toleransı Ø6 - Ø32 arası h6 Ø3-4-5 arası h4 tolerans

Shrink Chuck

SK (DIN 69871)

Form
AD/B

G2.5
25.000 RPM



Schrumpffutter

Isıtmalı Takım Tutucu

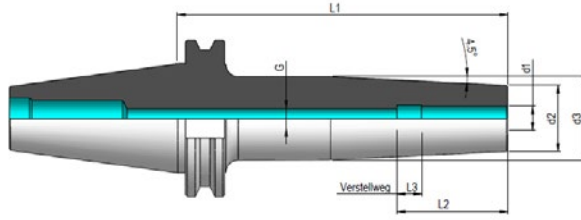

Order No. Bestell-Nr. Sipariş No.	SK	d1	l1	d2	d3	l2	l3	g
140.25.406	SK40	6	160	21	27	36	10	M5
140.25.408	SK40	8	160	21	27	36	-	M6
140.25.410	SK40	10	160	24	32	41	-	M8x1
140.25.412	SK40	12	160	24	32	47	-	M10x1
140.25.414	SK40	14	160	27	34	47	-	M10x1
140.25.416	SK40	16	160	27	34	50	-	M12x1
140.25.418	SK40	18	160	33	42	50	-	M12x1
140.25.420	SK40	20	160	33	42	52	-	M16x1
140.25.425	SK40	25	160	44	53	58	-	M16x1
140.25.432	SK40	32	160	33	42	52	-	M16x1
150.25.106	SK50	6	80	21	27	36	-	M5
150.25.108	SK50	8	80	21	27	36	-	M6
150.25.110	SK50	10	80	24	32	41	-	M8x1
150.25.112	SK50	12	80	24	32	47	-	M10x1
150.25.114	SK50	14	80	27	34	47	-	M10x1
150.25.116	SK50	16	80	27	34	50	-	M12x1
150.25.118	SK50	18	80	33	42	50	-	M12x1
150.25.120	SK50	20	80	33	42	52	-	M16x1
150.25.125	SK50	25	100	44	53	58	-	M16x1
150.25.132	SK50	32	100	44	53	62	-	M16x1

Application : For mounting of solid carbide and HSS cutters Ø6 - Ø32 with h6 tolerance and Ø3-4-5 with h4 tolerance

Verwendung : Zum Spannen von HM- und HSS Werkzeugschaften Ø6 - Ø32 mit h6-Toleranz und bei Ø3-4-5 mit h4-Toleranz

Açıklama : Şaftı karbür ve HSS takımlar için şaft toleransı Ø6 -Ø32 arası h6 Ø3-4-5 arası h4 tolerans

Shrink Chuck

SK (DIN 69871)

Form
AD/BG2.5
25.000 RPM

Schrumpffutter

Isıtmalı Takım Tutucu

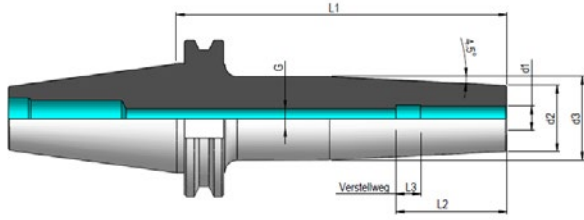

Order No. Bestell-Nr. Sipariş No.	SK	d1	l1	d2	d3	l2	l3	g
150.25.306	SK50	6	120	21	27	36	10	M5
150.25.308	SK50	8	120	21	27	36	-	M6
150.25.310	SK50	10	120	24	32	41	-	M8x1
150.25.312	SK50	12	120	24	32	47	-	M10x1
150.25.314	SK50	14	120	27	34	47	-	M10x1
150.25.316	SK50	16	120	27	34	50	-	M12x1
150.25.318	SK50	18	120	33	42	50	-	M12x1
150.25.320	SK50	20	120	33	42	52	-	M16x1
150.25.325	SK50	25	120	44	53	58	-	M16x1
150.25.332	SK50	32	120	44	53	62	-	M16x1
150.25.406	SK50	6	160	21	27	36	10	M5
150.25.408	SK50	8	160	21	27	36	-	M6
150.25.410	SK50	10	160	24	32	41	-	M8x1
150.25.412	SK50	12	160	24	32	47	-	M10x1
150.25.414	SK50	14	160	27	34	47	-	M10x1
150.25.416	SK50	16	160	27	34	50	-	M12x1
150.25.418	SK50	18	160	33	42	50	-	M12x1
150.25.420	SK50	20	160	33	42	52	-	M16x1
150.25.425	SK50	25	160	44	53	58	-	M16x1
150.25.432	SK50	32	160	44	53	62	-	M16x1

Application : For mounting of solid carbide and HSS cutters Ø6 - Ø32 with h6 tolerance and Ø3-4-5 with h4 tolerance

Verwendung : Zum Spannen von HM- und HSS Werkzeugschaften Ø6 - Ø32 mit h6-Toleranz und bei Ø3-4-5 mit h4-Toleranz

Açıklama : Şaftı karbür ve HSS takımlar için şaft toleransı Ø6 -Ø32 arası h6 Ø3-4-5 arası h4 tolerans

Hydraulic Chuck

SK (DIN 69871)

Form
AD/B

G6.3
15.000 RPM



Hydro-Dehnspannfutter

Hidrolik Takım Tutucu

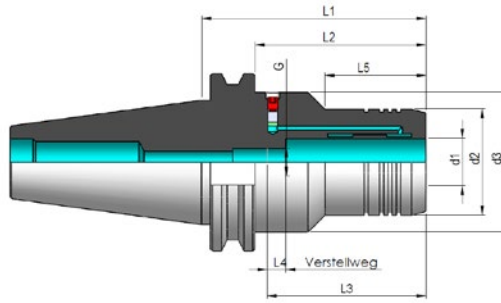

Order No. Bestell-Nr. Sipariş No.	SK	d1	d2	d3	l1	l2	l3	l4	l5	g
140.30.106	SK40	6	26	50	68	49	37	10	33	M5
140.30.108	SK40	8	28	50	68	49	37	10	33	M6
140.30.110	SK40	10	30	50	72	53	42	10	37	M8x1
140.30.112	SK40	12	32	50	77	58	47	10	42	M10x1
140.30.114	SK40	14	34	50	77	58	47	10	42	M10x1
140.30.116	SK40	16	38	50	80	61	52	10	43	M12x1
140.30.118	SK40	18	40	50	80	61	52	10	43	M12x1
140.30.120	SK40	20	42	50	82	63	52	10	47	M12x1
140.30.125	SK40	25	50	63	117	98	58	10	51	M16x1
140.30.132	SK40	32	60	63	117	98	62	10	56	M16x1
150.30.106	SK50	6	26	80	68	49	37	10	33	M5
150.30.108	SK50	8	28	80	68	49	37	10	33	M6
150.30.110	SK50	10	30	80	72	53	42	10	37	M8x1
150.30.112	SK50	12	32	80	77	58	47	10	42	M10x1
150.30.114	SK50	14	34	80	77	58	47	10	42	M10x1
150.30.116	SK50	16	38	80	80	61	52	10	45	M12x1
150.30.118	SK50	18	40	80	80	61	52	10	45	M12x1
150.30.120	SK50	20	42	80	82	63	52	10	47	M16x1
150.30.125	SK50	25	50	80	87	68	58	10	52	M16x1
150.30.132	SK50	32	60	80	91	72	62	10	56	M16x1
150.30.140	SK50	40	70	70	120	101	74	10	101	M16x1



Reduction Sleeve
Reduzierhülse
Hidrolik Pensi

156

