



High speed precision spindles

# SCHEDA TECNICA TMPE 4 SC L



MODELLO	TENSIONE [Volt]	FREQUENZA [Hz]	GIRI	POT. RESA [Kw]	ASSORB. [Amp]	Cos j	PESO [Kg]
TMPE4 10/2	220/380	50	3000	0,65	3,30/1,90	0,72	11,5
TMPE4 10/2	220/380	100	6000	1,10	4,90/2,80	0,77	11,5
TMPE4 10/2	220/380	200	12000	2,20	9,70/5,60	0,77	11,5
TMPE4 10/2	220/380	300	18000	3,30	13,70/7,90	0,80	11,5
TMPE4 10/2	220/380	400	24000	3,30	13,70/7,90	0,80	11,5
TMPE4 14/2	220/380	50	3000	1,10	5,50/3,15	0,72	13,5
TMPE4 14/2	220/380	100	6000	2,20	9,50/5,50	0,77	13,5
TMPE4 14/2	220/380	200	12000	3,70	15,00/8,70	0,78	13,5
TMPE4 14/2	220/380	300	18000	5,60	20,00/11,50	0,85	13,5
TMPE4 14/2	220/380	400	24000	5,60	20,00/11,50	0,85	13,5

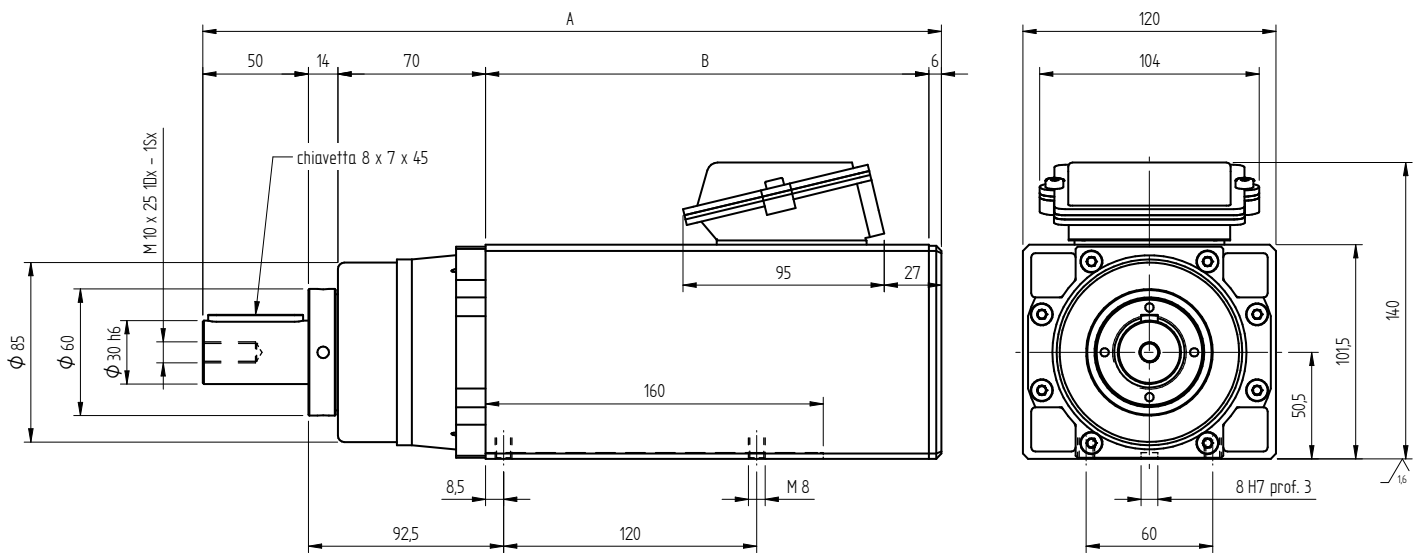

TIPO	A	B
TM PE4 10/2	350	210
TM PE4 14/2	390	250

